

Final Report for the Visiting Researcher Program in 2015

SYSTEM DEVELOPMENT OVER THE MONITORING FOR EARLY WARNING OF POPULATION FROM THE THREAT OF LANDSLIDES AND MUDFLOWS



Prepared By

Elyor Fozilov

Leading specialist

State Committee of the Republic of Uzbekistan

On Geology and Mineral Resources

Visiting Researcher (ADRC)

August – November 2015

Disclaimer

This report was compiled by an ADRC visiting researcher (VR) from ADRC member countries.

The views expressed in the report do not necessarily reflect the views of the ADRC. The boundaries and names shown and the designations used on the maps in the report also do not imply official endorsement or acceptance by the ADRC.

CONTENTS

1. GENERAL INFORMATION	<u>4</u>
1.1. REPUBLIC OF UZBEKISTAN	<u>4</u>
1.2. JAPAN	<u>6</u>
2. STATE COMMITTEE OF THE REPUBLIC OF UZBEKISTAN ON GEOLOGY AND MINERAL RESOURCES (GOSCOMGEOLOGY)	<u>9</u>
2.1. History of Geological Survey	<u>9</u>
2.2. About committee	<u>10</u>
2.3. Structure of Goscomgeology	<u>10</u>
2.4. Main Tasks of Goscomgeology	<u>11</u>
2.5. Mineral resources deposits, revealed during Independence years	<u>11</u>
3. DISASTER MANAGEMENT	<u>12</u>
3.1. Disaster Management in Uzbekistan	<u>12</u>
3.1.1. Natural Hazards in Uzbekistan	<u>12</u>
3.1.2. Disaster Management System in Uzbekistan	<u>12</u>
3.1.3. Disaster Management Strategy and Policy in Uzbekistan	<u>15</u>
3.2. Disaster Management in Japan	<u>16</u>
3.2.1. Natural Hazards in Japan	<u>16</u>
3.2.2. Disaster Management System of Japan	<u>18</u>
3.2.3. Disaster Management Strategy, Policy, and Plan in Japan	<u>22</u>
3.2.4. Japan's Current Disaster Prevention Measures	<u>23</u>
3.2.5. Future Probable-Disaster and Countermeasure	<u>31</u>
4. MONITORING LANDSLIDES FOR THE ENSURE THE SAFETY POPULATION IN MOUNTAIN AND FOOTHILL AREAS	<u>35</u>
4.1. Monitoring Landslides in Uzbekistan	<u>35</u>
4.1.1. Activity State Service on Monitoring over the Dangerous Geological Processes	<u>35</u>
4.1.2. The Structure of Monitoring	<u>36</u>
4.1.3. The Structure of the Monitoring System and Alerting	<u>38</u>
4.1.4. Factors formation of landslides	<u>38</u>

4.1.5. Monitoring system landslides	<u>42</u>
4.2. Monitoring Landslides in Japan	<u>49</u>
4.2.1. About the Japan Landslide Society	<u>49</u>
4.2.2. Organizational structure	<u>51</u>
4.2.3. Major Landslides in Recent years and their impact	<u>52</u>
4.2.4. New methods of monitoring landslides and maintaining them in a stable state	<u>59</u>
4.2.4.1. New nailing network system	<u>61</u>
5. MUDFLOWS AND INFORMATION	<u>72</u>
5.1. Mudflows in Uzbekistan	<u>72</u>
5.2. Mudflows in Japan	<u>77</u>
6. CONCLUSIONS	<u>89</u>

1. GENERAL INFORMATION.

1.1. REPUBLIC OF UZBEKISTAN

1.1.1. Geography.

Uzbekistan – a country located in the central part of Central Asia.

Name of the State "**Republic of Uzbekistan**".

Uzbekistan has an area of 447,400 square kilometers. It is the 56th largest country in the world by area and the 42nd by population. Among the [CIS](#) countries, it is the 5th largest by area and the 3rd largest by population.

Bordering [Kazakhstan](#) and the [Aral Sea](#) to the north and northwest, [Turkmenistan](#) to the southwest, [Tajikistan](#) to the southeast, and [Kyrgyzstan](#) to the northeast, Uzbekistan is one of the largest [Central Asian](#) states and the only Central Asian state to border all the other four. Uzbekistan also shares a short border (less than 150 km) with [Afghanistan](#) to the south (fig 1).



Fig. 1

1.1.2. Administrative Divisions.

Uzbekistan is divided into 12 provinces (compound noun viloyati e.g., Toshkent viloyati, Samarqand viloyati, etc.), (fig.3) one autonomous republic (respublika, compound noun respublikasi e.g. Qaraqalpaqstan Avtonom Respublikasi, Karakalpakis



Fig. 2

tan Autonomous Republic, etc.),
and one independent city (shahar. compound noun shahri, e.g., Toshkent shahri).



Fig. 3

Division	Capital City	Area (km ²)	Population	Key
Andijan Region	Andijan	4,200	2,477,900	2
Bukhara Region	Bukhara	39,400	1,576,800	3
Fergana Region	Fergana	6,800	2,997,400	4
Jizzakh Region	Jizzakh	20,500	1,090,900	5
Karakalpakstan Republic	Nukus	160,000	1,612,300	14
Kashkadarya Region	Karshi	28,400	2,537,600	8
Khorezm Region	Urgench	6,300	1,517,600	13
Namangan Region	Namangan	7,900	2,196,200	6
Navoiy Region	Navoiy	110,800	834,100	7
Samarkand Region	Samarkand	16,400	3,032,000	9
Surkhandarya Region	Termez	20,800	2,012,600	11
Syrdarya Region	Gulistan	5,100	698,100	10
Tashkent City	Tashkent	335	2,352,900	1
Tashkent Region	Tashkent	15,300	2,537,500	12

Table 1.

1.1.3. Demographics.

Uzbekistan is Central Asia's most populous country. Its 31,025,500 citizens comprise nearly half the region's total population. The population of Uzbekistan is very young: 34.1% of its people are younger than 14. According to official sources, [Uzbeks](#) comprise a majority (80%) of the total population. Other ethnic groups include [Russians](#) 5.5%, [Tajiks](#) 5% (official estimate and disputed), [Kazakhs](#) 3%, [Karakalpaks](#) 2.5% and [Tatars](#) 1.5%.



Fig. 4

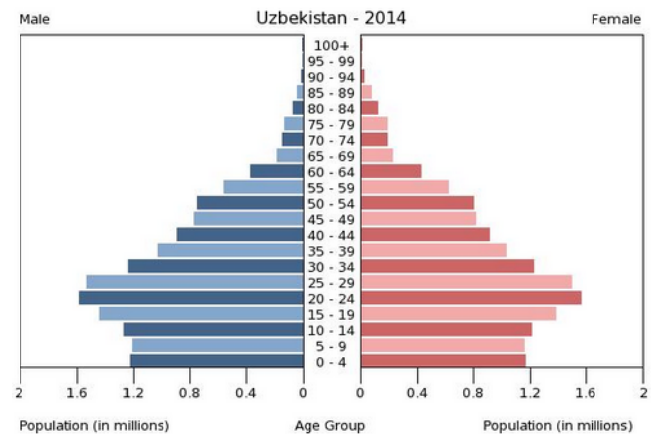

Fig. 5

1.2. JAPAN.

1.2.1. Geography.

Japan has a total of 6,852 islands extending along the [Pacific coast](#) of East Asia. The country, including all of the islands it controls, lies between latitudes 24° and 46°N, and longitudes 122° and 146°E. The main islands, from north to south, are [Hokkaidō](#), [Honshū](#), [Shikoku](#) and [Kyūshū](#). The [Ryūkyū Islands](#), including [Okinawa](#), are a chain to the south of Kyūshū. Together they are often known as the [Japanese Archipelago](#).

About 73 percent of Japan is forested, mountainous, and unsuitable for [agricultural](#), [industrial](#), or [residential](#) use. As a result, the habitable zones, mainly located in coastal areas, have extremely high population densities. Japan is one of the [most densely populated countries](#) in the world.

The islands of Japan are located in a [volcanic](#) zone on the [Pacific Ring of Fire](#). They are primarily the result of large oceanic movements occurring over hundreds of millions of years from the mid-Silurian to the Pleistocene as a result of the [subduction](#) of the [Philippine Sea Plate](#) beneath the continental [Amurian](#)

Plate and Okinawa Plate to the south, and subduction of the Pacific Plate under the Okhotsk Plate to the north. Japan was originally attached to the eastern coast of the Eurasian continent. The subducting plates pulled Japan eastward, opening the Sea of Japan around 15 million years ago.

Japan has around 200 volcanoes, 110 are active (Fig. 7).

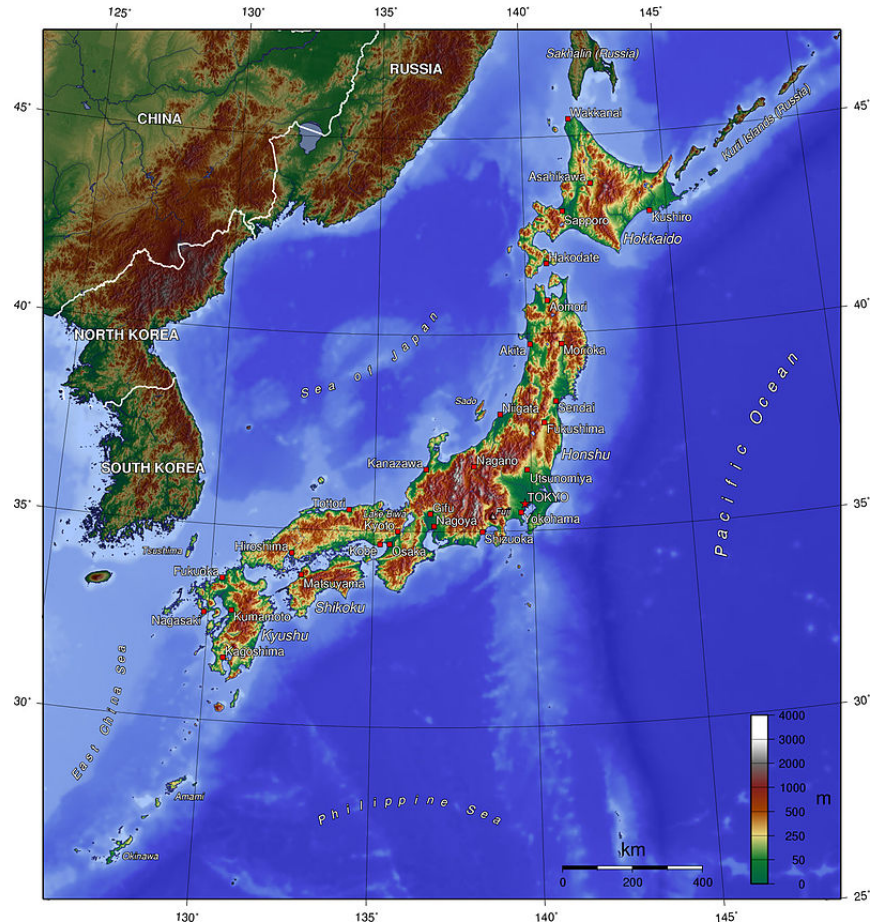

Fig. 6.



Fig. 7.

1.2.2. Administrative Divisions.

Japan 日本国 <i>Nippon-koku</i> <i>Nihon-koku</i>	
	
Anthem: <i>"Kimigayo"</i> "君が代"	
Government Seal of Japan 五七桐 (Go-Shichi no Kiri?)	
	
Capital	Tokyo
National language	Japanese
Government	Unitary parliamentary constitutional monarchy
- Emperor	Akihito
- Prime Minister	Shinzō Abe
Legislature	National Diet
- Upper house	House of Councillors
- Lower house	House of Representatives
Area	377,944 km ²
Population	126 659 683
Currency	Yen (¥)

Japan consists of forty-seven prefectures, each overseen by an elected governor, legislature and administrative bureaucracy. Each prefecture is further divided into cities, towns and villages. The nation is currently undergoing administrative [reorganization by merging](#) many of the cities, towns and villages with each other. This process will reduce the number of sub-prefecture administrative regions and is expected to cut administrative costs.

- Area: 377,900 km²
- Population: 127.8 million
- Prefectures: 47
- Municipalities: 1,718

Fig. 8.

2. STATE COMMITTEE OF THE REPUBLIC OF UZBEKISTAN ON GEOLOGY AND MINERAL RESOURCES (GOSKOMGEOLOGY).

2.1. History of Geological Survey.

The beginning of regular studying of geology of Central Asia has begun in 60th years XIX century when the first geological maps of Turkestan region and summary reports on minerals have been made.

In 1920, The Central Asia University (nowadays National University of Uzbekistan named after Mirzo Ulugbek) initiated training for experts-geologist.

In 1926, Central Asia Department of Committee of Geology (SAO Geolcom) which in 1930 transformed to the Central Asia regional geological survey (SARGRU), was organized.

In 1937, there is a Central Asia Geology Trust, and in 1938 – Uzbek Geological Agency of the Committee on geology and subsoil protection USSR.

During the period 1941-45, Uzbek geological agency was purposefully carrying out prospecting and exploration for fuel and energy and strategic raw material.

During the period 1946-57, intense geological researches were carried out, for their realization, specialized enterprises for prospecting and exploration for petroleum, gas, non-ferrous, rare and precious metals, mining chemical and industrial minerals, and construction materials.

In 1957, geological survey of the various ministries and departments were integrated and General Geology and Subsoil Protection Office at Cabinet Council.

On 17th of January 2007, the Order of the President of Republic of Uzbekistan “About measures on radical improvement of arrangement of exploration and activity of State Committee of the Republic of Uzbekistan on Geology and mineral resources” that had given a powerful impulse to branch development.

On 12th of February 1991, according to Decree of the President of Uzbekistan of Republic of Uzbekistan №UP-142 the State committee of the Republic of Uzbekistan on geology and mineral resources (Goscomgeology RUz) was formed.

On 23rd of September 1994, Oliy Majlis passed the “Subsoil Law RUz”, and on 13th of December 2002, its redraft was approved.

2.2. About committee.

State committee of the Republic of Uzbekistan on geology and mineral resources carries out geologic analysis of entrails with the purpose of strengthening and development of the mineral base of the mining and process industry, provides coordination of different branches of industry connected to the geologic analysis of entrails of the territory of Uzbekistan, carries out the state control over the geologic analysis of entrails by all enterprises and organizations irrespective of patterns of ownership, creates and provides functioning of a databank on the geologic structure of entrails and mineral resources of the republic, conducting the State balance on mineral reserves, etc. with the purpose of definition of conditions of their economic and rational use.



Fig. 9.

2.3. Structure of Goscomgeology.

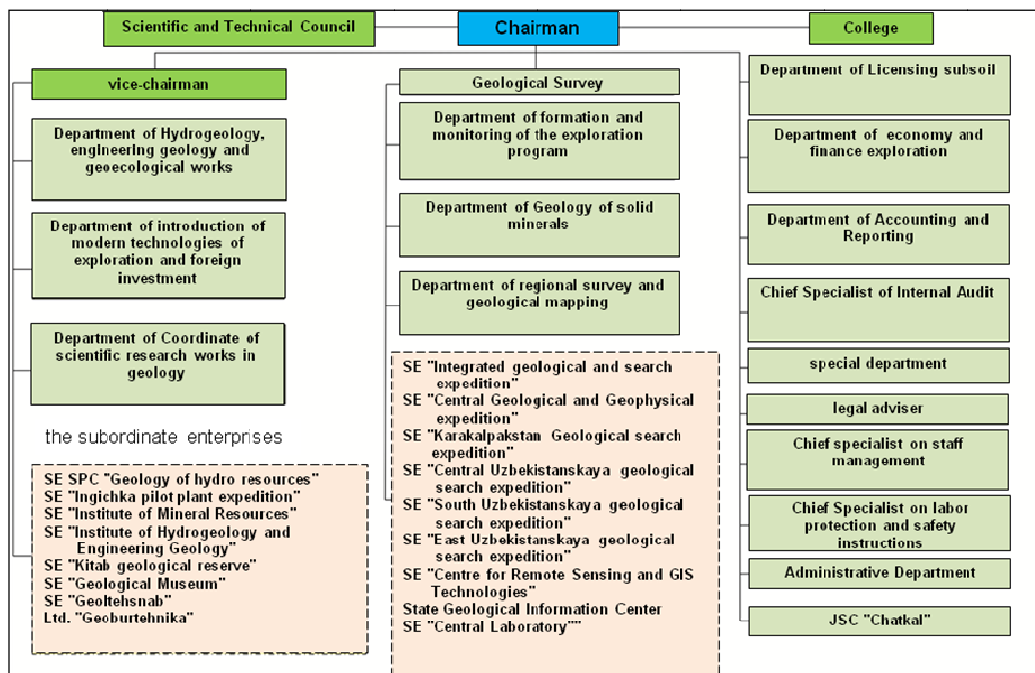

Fig. 10.

2.4. Main Tasks of Goscomegeology.

- Implementation of a unified state policy in the field of geological study, use and protection of subsoil and reproduction of mineral resources, the implementation of public administration in the field of mining relations;
- Organization of geological exploration of mineral resources, forecasting and identifying fields for geological and economic evaluation of mineral resources (except hydrocarbons), justification of the possibility of subsoil use for purposes not related to the extraction of mineral resources;
- Management, within their competence, the state subsoil fund and the state fund of geological materials of stone, as well as specially protected geological objects;
- Coordination of activities related to geological exploration in Uzbekistan (with the exception of work on hydrocarbons).

2.5. Mineral resources deposits, revealed during Independence years.

After independence, the Republic of Uzbekistan has significantly increased its position at the world market of mineral resources in many directions.

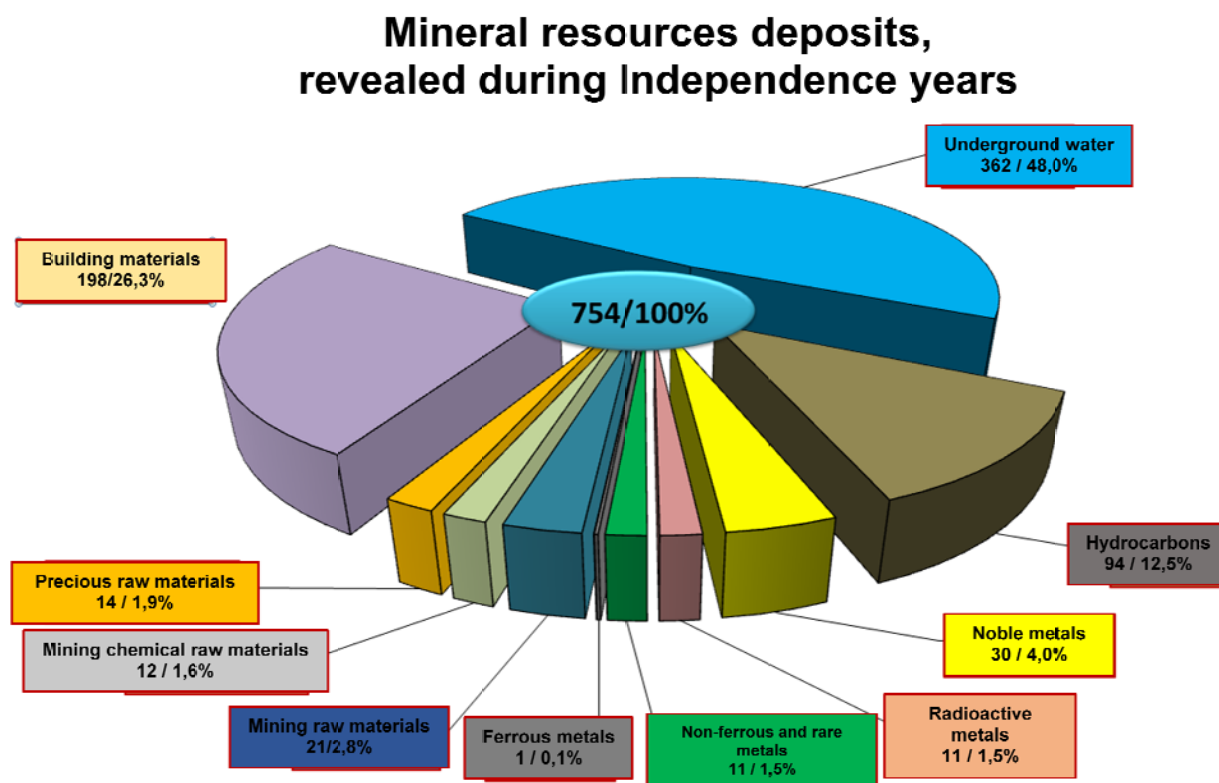

Fig. 11.

3. DISASTER MANAGEMENT.

3.1. Disaster Management in Uzbekistan.

3.1.1. Natural Hazards in Uzbekistan.

Natural Hazards Likely to Affect the Country.

Uzbekistan ranks high among countries that have endured significant loss of life and property due to earthquakes and other natural disasters. As one of the most seismic active regions in Central Asia, Uzbekistan is struck by earthquakes in the eight to ten point ranges. In addition to its seismic vulnerability, Uzbekistan is affected by hydro-meteorological hazards affecting the agricultural sector with seasonal floods and periods of drought. Other threats from landslides, locust invasions and avalanche have been reported to affect the lives and livelihood of Uzbekistan's population.

3.1.2. Disaster Management System in Uzbekistan.

Administrative System

The State system of prevention and emergency response consists of controls and capabilities of the Council of Ministers of the Republic of Karakalpakstan, 12 regions, districts and municipalities, ministries and departments, enterprises, institutions and organizations.

The structure and functioning of the state system of prevention and emergency action by the Cabinet of Ministers of the Republic of Uzbekistan.

The Cabinet of Ministers of the Republic of Uzbekistan:

- ensures the creation of state reserves of financial and material resources for disaster management, as well as the procedure for its use;
- Responsible for financial and resource support capabilities for the prevention and liquidation of emergency situations, equip them special appliances and other material and technical means;
- Classification of states of emergency situations and determines the degree of involvement of the executive power to eliminate them;
- carry out the activities of ministries, departments, local authorities in the protection of population and territories from emergency situations.

Specially authorized state body for the protection of the **Ministry of Emergency Situations** for Emergency Situations of the Republic of Uzbekistan.

Ministry of Emergency Situations:

- develop and adopt action to prevent emergency situations save lives and preserve health, protect the material and cultural values, as well as the recovery and reduce damages in emergency situations;
- organizes the development and implementation of targeted programs and research in the field of population and territories from emergency situations;
- takes within their jurisdiction, obligatory for execution by ministries, departments, enterprises, institutions and organizations, officials and citizens;
- organize the preparation of controls, forces and protection frames the population and territories for actions in emergency situations;
- controls the forces and means for dealing with emergencies, creates a control posts, warning systems and communications;
- organizes the emergency rescue and other emergency operations in emergency situations;
- carries out state control over the implementation protection measures the population and territories from emergency situations.

Legal System and Framework of DM in Uzbekistan.

The Ministry of Emergency Situations of the Republic of Uzbekistan is a central government body responsible for directing and coordinating activities in the field of civil protection, prevention and response to emergency situations caused by accidents, catastrophes and natural disasters.

Ministry of Emergency Situations of the Republic of Uzbekistan in accordance with the Constitution, laws and other acts of the Oliy Majlis of the Republic of Uzbekistan, decrees, regulations, and orders of the President of the Republic of Uzbekistan, resolutions and orders of the Cabinet of Ministers and the international treaties of the Republic of Uzbekistan on the management Emergencies.

Ministry of Emergency Situations of the Republic of Uzbekistan carries out its activities in cooperation with the Council of Ministers of the Republic of Karakalpakstan, regions, cities, districts, environmental and specially authorized state bodies.

Ministry of Emergency situations has few documents for disaster management of the Republic of Uzbekistan. There are:

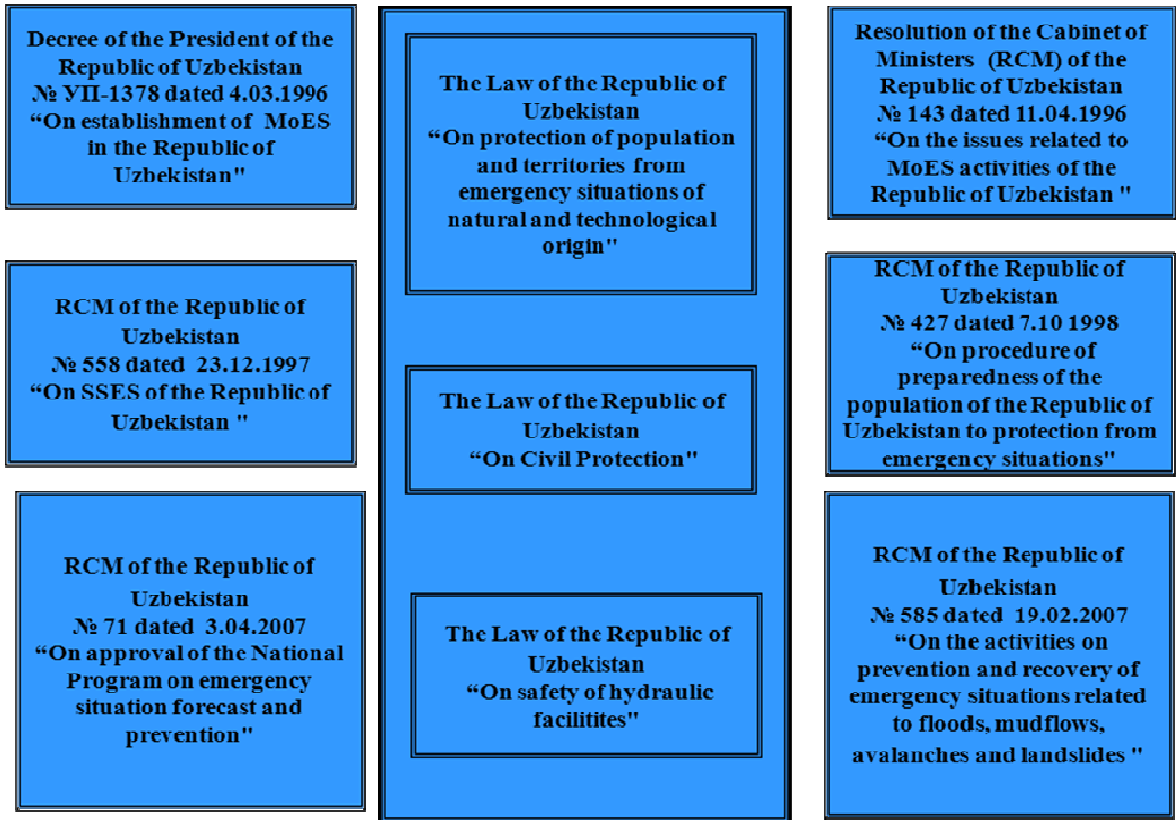

Fig. 12.

Structure of Disaster Management.

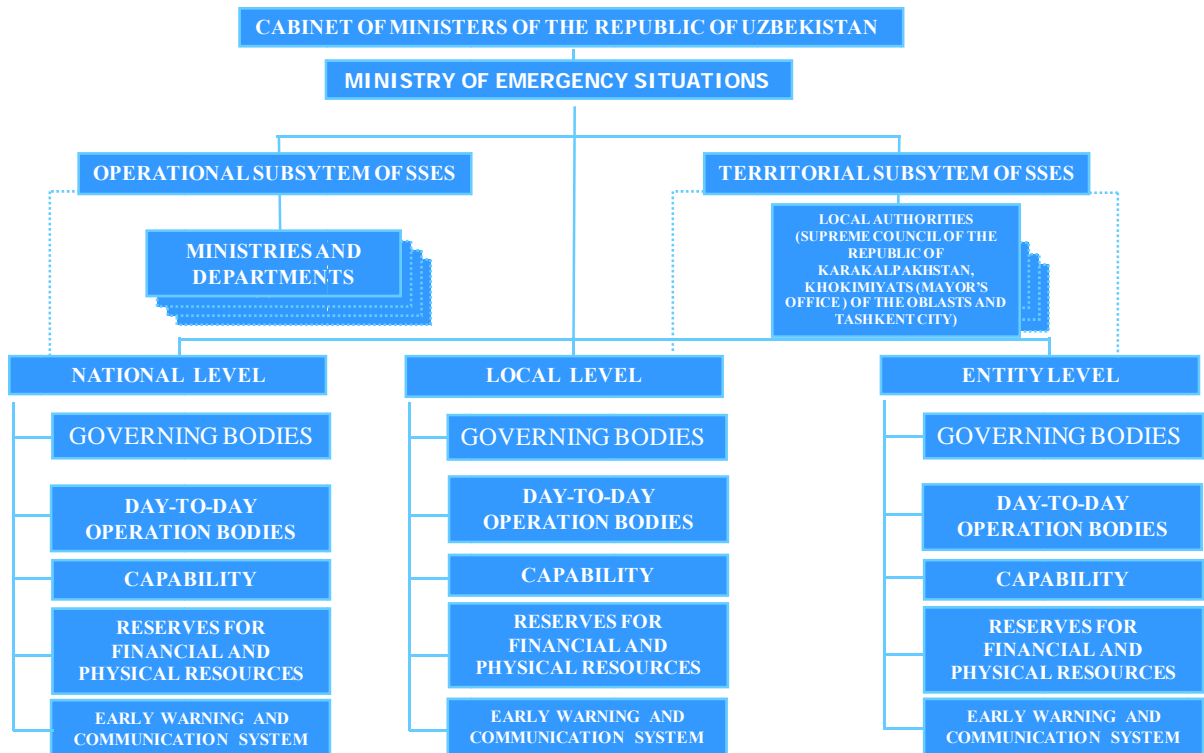

Fig. 13.

3.1.3. Disaster Management Strategy and Policy in Uzbekistan.

For the implementation of the state policy in the field of vital interests of the individual, society and the state act legal framework regulating the activities the state authorities and enterprises and organizations, as well as civil self in the area of civil protection. The Laws of the Republic of Uzbekistan "On protection of population and territories from emergency situations of natural and man-made" and "Civil Protection", and a number of resolutions of the Cabinet of Ministers.

The world practice shows that timely prevention of hazards of natural and man-made hazards, the priority realization of measures to prevent and reduce their negative impacts are much more economical and more effective than emergency response.

In order to realize these tasks, the Ministry of Emergency Situations together with the interested ministries and departments of the Republic of Uzbekistan, the Council of Ministers of the Republic of Karakalpakstan, regional and Tashkent city State program is designed to forecast and prevention of emergency situations (hereinafter - the State program).

The purpose of this state program is provide a guaranteed level of protection of the population and territories from emergency situations, risk reduction and mitigation of accidents and natural disasters in the country, taking into account achievements of the national science and technology, as well as international experience in this field.

The State Program included the following:

A. Natural disaster risk reduction

1. Risk reduction program for the effects of earthquake
2. Program on prevention of floods, mudflows, avalanches and landslides
3. Program on prevention of epidemics, epizootic outbreak, epiphytotes

B. Technological disaster risk reduction

4. Program on prevention of chemical emergency
5. Program on prevention of accidents at explosive and fire hazardous sites
6. Program on prevention of accidents at the sites and power network
7. Program on prevention of transport accidents and disaster (motor transport, railway, aircraft, the Metro)
8. Program on prevention of disaster at hydraulic engineering structures

C. Early warning of population

9. Program on creation of territorial and local systems and early warning

D. Improvement of emergency rescue services

10. Program on equipping the Center on training and advanced training of rescue workers of MoES with rescue gear, equipment, outfit and on construction of training centers

E. Training of the population on disaster preparedness

11. Program on training of population

3.2. Disaster Management in Japan.

3.2.1. Natural Hazards in Japan.

Japan is affected by Typhoon mostly every year and Volcanic disasters triggered by eruption and volcanic earthquake. Japan is earthquake prone area due to the geological formation with plate boundaries of the Pacific plate, the Philippine Sea plate, the Eurasian plate, and the North American plate.

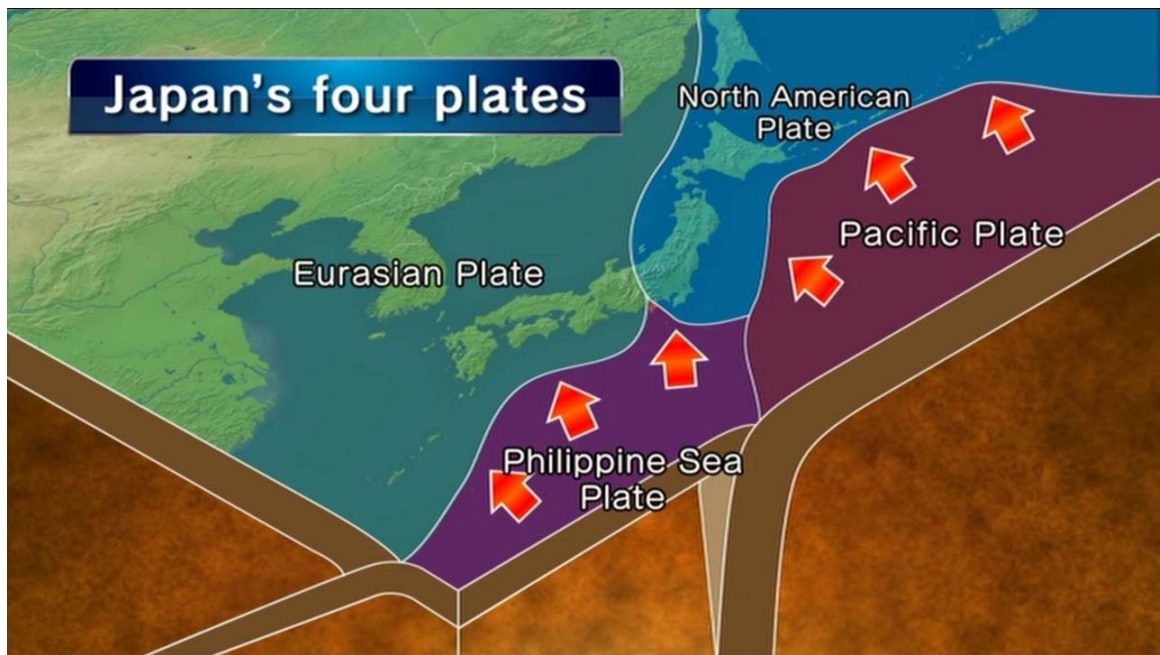

Fig. 14.

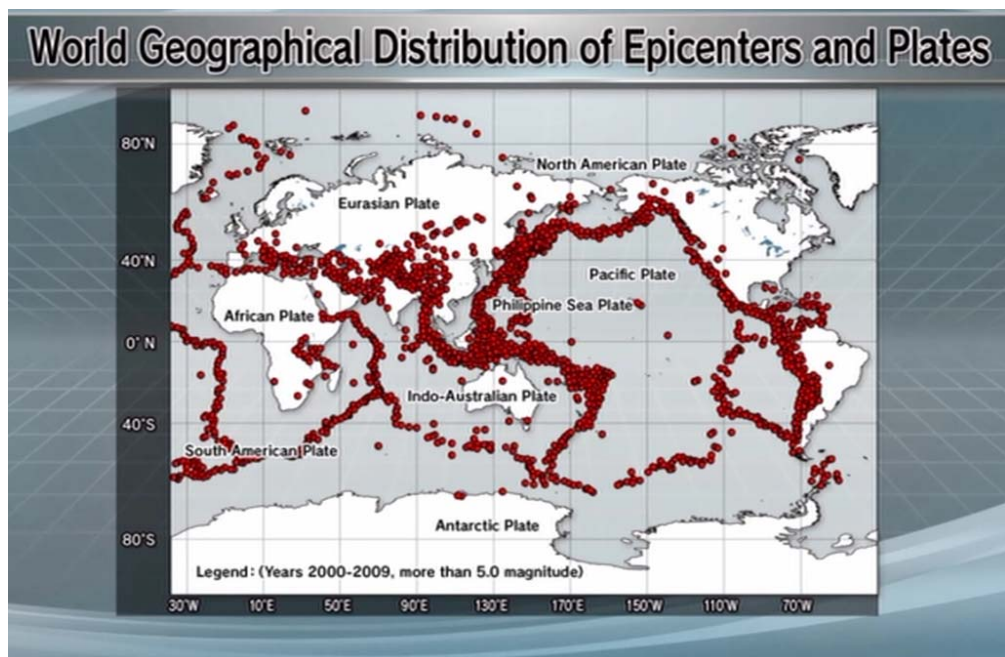

Fig. 15.

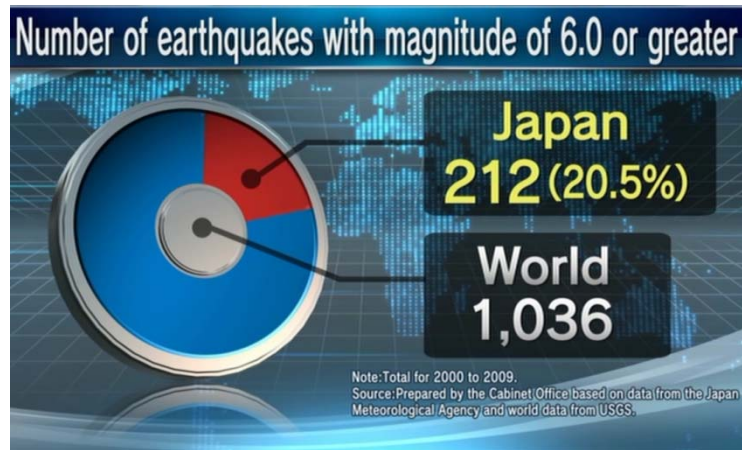

Fig. 16.

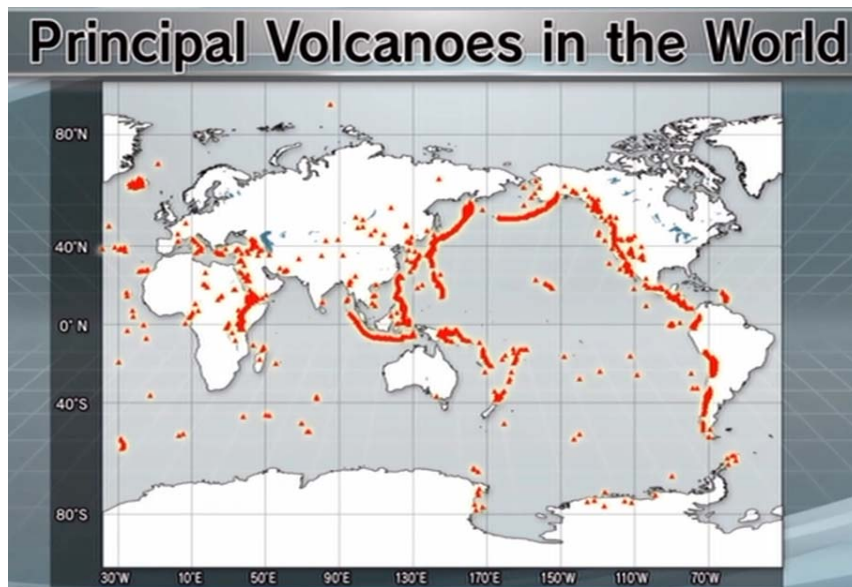

Fig. 17.



Fig. 18.

3.2.2. Disaster Management System of Japan.

Administrative System

Japan has three (3) administrative levels of governance; national, prefectural and municipal. Each level of governments has its own disaster management organizations, policy frameworks and budgets. When disasters occur, municipalities respond first. In case disasters are large in scale beyond their capacity, national and prefectural governments provide every possible support.

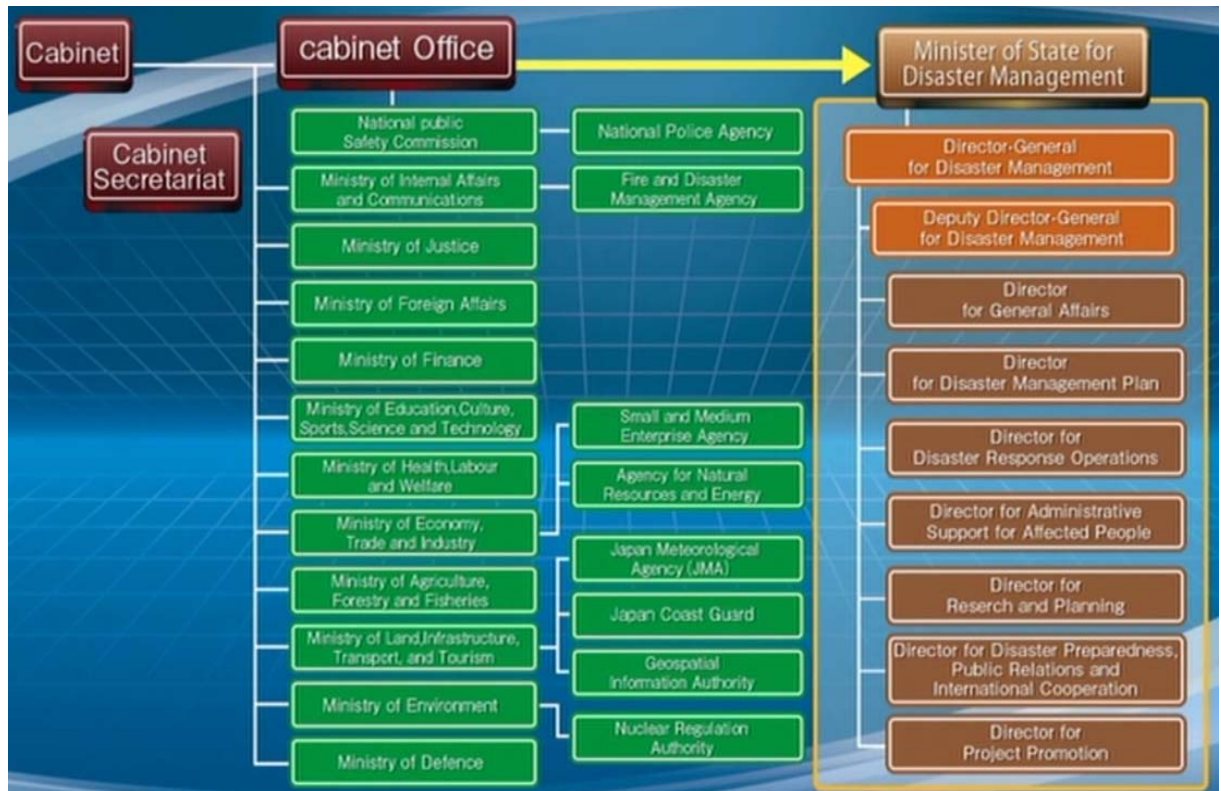

Fig. 19.

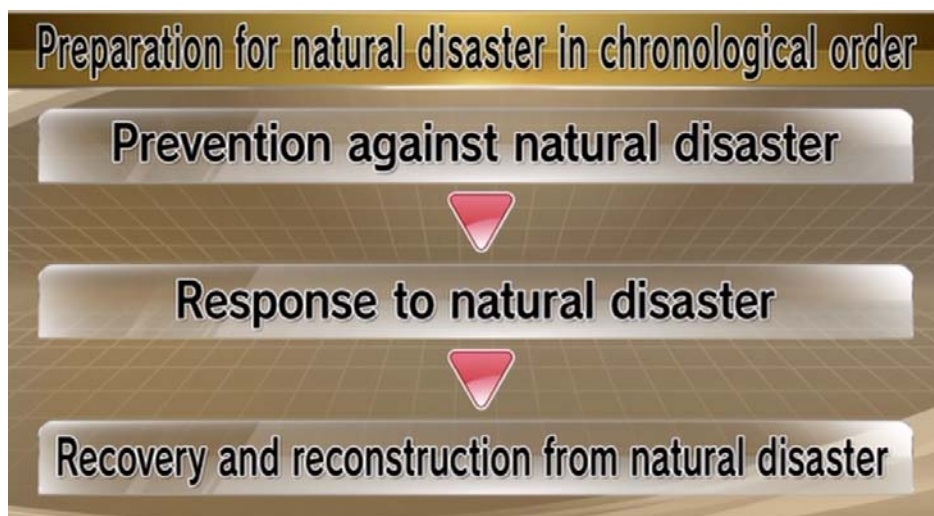

Fig. 20.

In Japan: 24 designated government agencies and 56 designated public institutions.

Structure of Disaster Management.

a) National Platform for Disaster Risk Reduction.

Under the Disaster Countermeasures Basic Act, the Central Disaster Management Council was formed, its brief being to ensure the comprehensiveness of disaster risk management and to discuss matters of importance with regard to disaster management.



Fig. 21.

b) National Organizations for Disaster Risk Reduction.

All the line ministries and agencies have responsibility to take actions related to disaster reduction within their own mandate. The Cabinet Office is responsible for formulating basic policies, strategies and guidelines for disaster reduction and for securing coordination of government disaster reduction activities.

Within the Cabinet Office, which is the secretariat for the Central Council, the Minister of State for Disaster Management has been assigned as the Minister State for Special Missions to take lead in the responsibilities for disaster reduction in the Natural Government.

The Minister is assisted by the department of the Cabinet Office Director-General for Disaster Management. The Director-General has mandate to handle planning and central coordination with regard to matters relating to basic policy on disaster risk reduction, and matters concerning disaster countermeasures in the event of a large-scale disaster.

Central Disaster Management Council

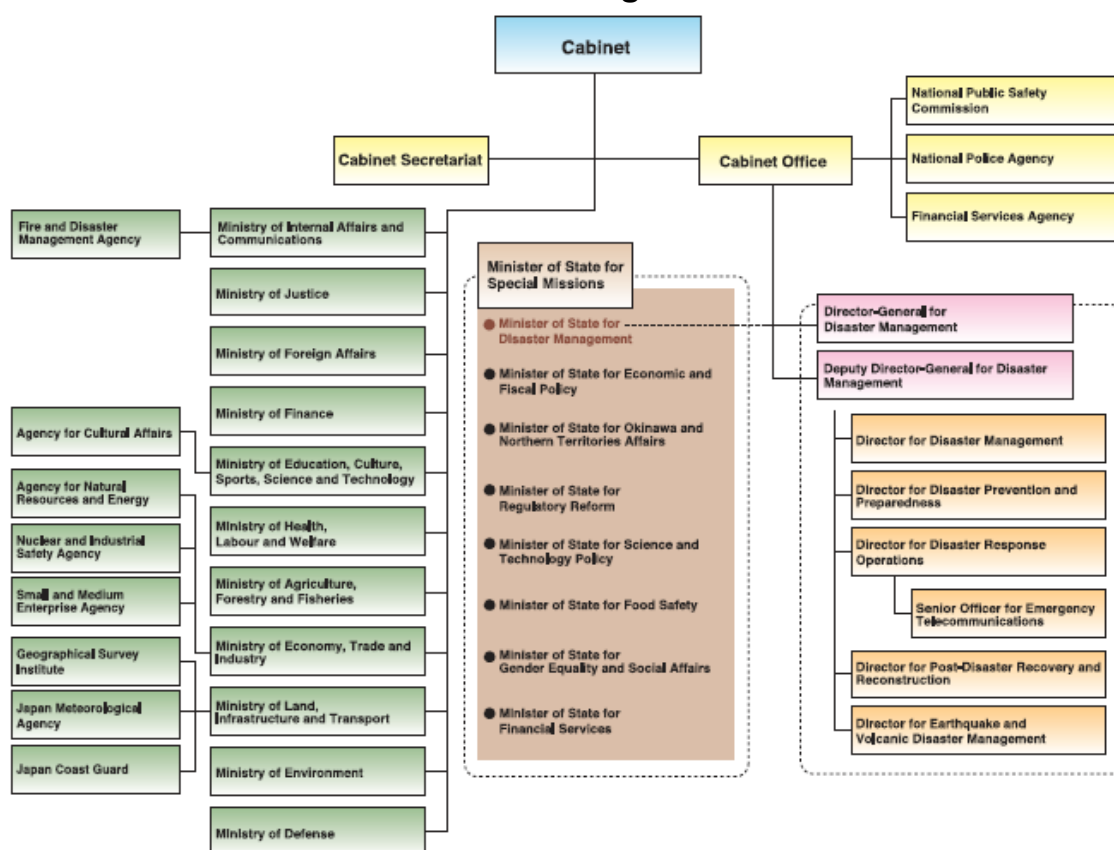

Fig. 22.

c) Local Organizations for Disaster Risk Reduction.

In prefectures and local municipalities, the prefectural and municipal Disaster Management Councils are established with the members of representatives of local government organizations including police and fire management department, and designated local public corporations. Implementation of disaster risk management measures is based on the Local Disaster Management Plans drafted by the Councils.

Legal System and Framework.

In order to applying to all of the disaster phases of prevention, mitigation and preparedness, emergency response as well as recovery and rehabilitation, relevant laws and regulations were enacted.

The cornerstone of legislation on disaster risk reduction is the Disaster Countermeasures Basic Act enacted in 1961.

The main features of the Act are:

- Responsibilities of national and local governments as well as the private sector and people;

- Organization of multi-sectorial coordination bodies for disaster risk management at the national and local levels;
- Disaster risk management planning system;
- Basic actions to be taken in each phase of the disaster management cycle: prevention preparedness, emergency response, and recovery rehabilitation;
- Annual Government Official Report on Disaster Countermeasures.

Relevant laws are as follows.

[Basic Acts]

1. Disaster Countermeasures Basic Act (1961)
2. Act on Prevention of Marine Pollution and Maritime Disaster (1970)
3. Act on Disaster Prevention in Petroleum Industrial Complexes and other Petroleum Facilities (1975)
4. Act on Special Measures for Large-scale Earthquakes (1978)
5. Act on Special Measures for Nuclear Disasters (1999)
6. Act on Special Measures for Promotion of Tonankai and Nankai Earthquake Disaster Management (2002)
7. Act on Special Measures for Promotion of Disaster Management for Trench-type Earthquakes in the Vicinity of the Japan and Chishima Trenches (2004)

[Disaster Prevention and Preparedness]

1. Erosion Control Act (1897)
2. Building Standard Law (1950)
3. Forest Act (1951)
4. Act on Temporary Measures for Disaster Prevention and Development of Special Land Areas (1952)
5. Meteorological Services Act (1952)
6. Seashore Act (1956)
7. Landslide Prevention Act (1958)
8. Act on Special Measures for Disaster Prevention in Typhoon-prone Areas (1958)
9. Act on Special Measures for Heavy Snowfall Areas (1962)
10. River Act (1964)
11. Act on Prevention of Steep Slope Collapse Disaster (1969)
12. Act on Special Measures for Active Volcanoes (1973)
13. Act on Special Financial Measures for Urgent Earthquake Countermeasure Improvement Projects in Areas for Intensified Measures (1980)
14. Act on Special Measures for Earthquake Disaster Countermeasures (1995)
15. Act on Promotion of the Earthquake-proof Retrofit of Buildings (1995)

16. Act on Promotion of Disaster Resilience Improvement in Densely Inhabited Areas (1997)
17. Act on Promotion of Sediment Disaster Countermeasures for Sediment Disaster Prone Areas (2000)
18. Specified Urban River Inundation Countermeasures Act (2003)

3.2.3. Disaster Management Strategy and Policy in Japan.

Basic Disaster Prevention Plan is the master plan and a basis for disaster reduction activities in Japan. Basic Disaster Prevention Plan is prepared by the Central Disaster Management Council in accordance with Article 34 of the Disaster Countermeasures Basic Act. The plan clarifies the duties assigned to the Government, public corporations and the local government in implementing measures. For easy reference to countermeasures, the plan also describes the sequence of disaster countermeasures such as preparation, emergency response, recovery and reconstruction according to the type of disaster.

Basic Disaster Prevention Plan has been reviewed annually and amended as needed. In a recent review in February 2008, the Basic Plan was revised based on the lessons learned in the recent disasters and the deliberation in the Central Council including the view points of necessity to take follow-up measures of priority issues and to facilitate nationwide movement for disaster reduction.

Besides of the Basic Disaster Prevention Plan, Disaster Management Operation Plan is made as a plan for each designated government organization and designated public corporation, and Local Disaster Management Plan is drafted as a plan for each prefectural and municipal disaster management council, based on the Basic Disaster Management Plan.



Fig. 23.

National Emergency Response Flow.

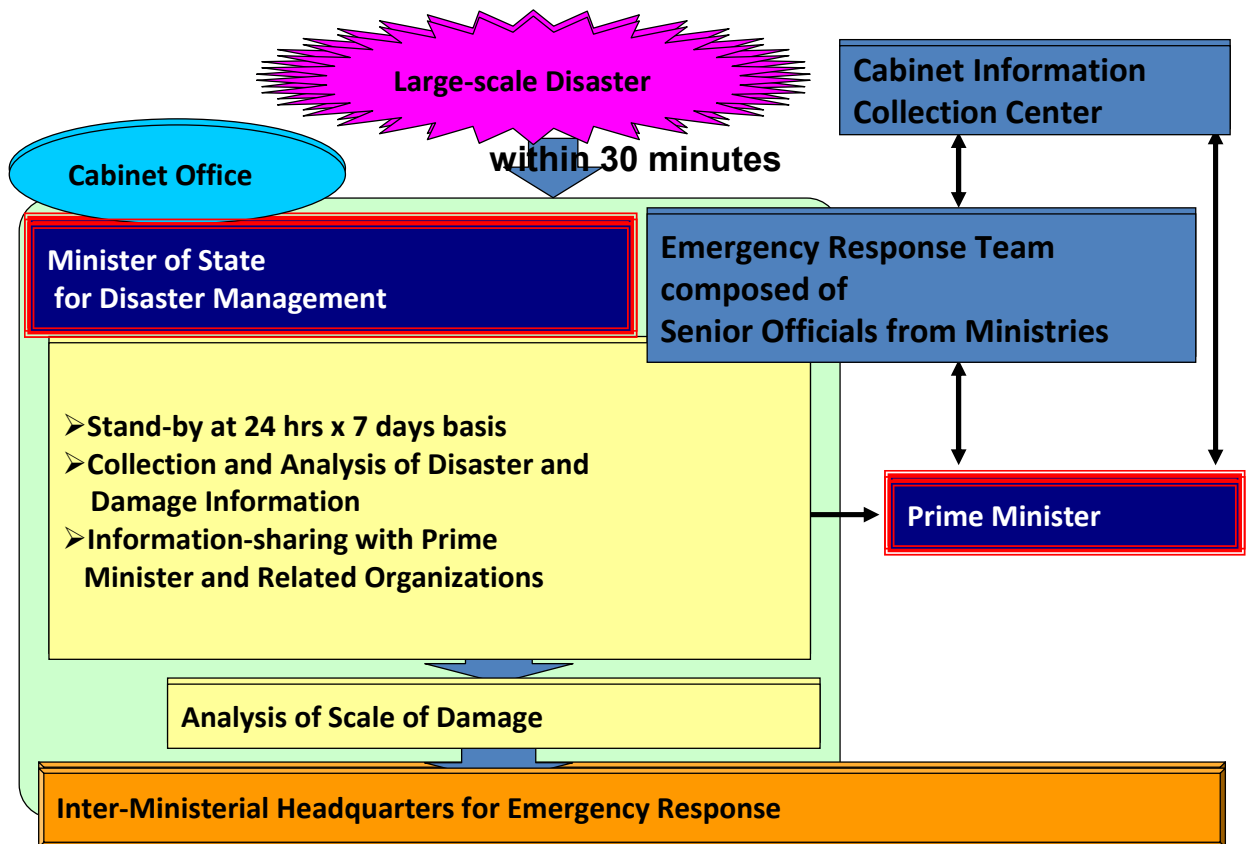

Fig. 24.

Further, disaster reduction perspectives are incorporated into relevant development plans such as Comprehensive National Development Plan, Social Infrastructure Development Priority Plan, Land Use Plan and urban and rural planning.

3.2.4. Japan's Current Disaster Prevention Measures.

In Japan Current disaster prevention measures:

1. Research and development.
2. Early Warning systems and Prevention against natural disaster.
3. Response to natural disaster.
4. Recovery and reconstruction.

1. Research and development.

JMA monitors seismic activities in and around Japan around the clock, and issues tsunami warning/information and earthquake information promptly when an earthquake occurs. In addition, JMA constructed a dense monitoring network

around the Tokai area in cooperation with relevant organizations in order to detect the precursor of the great earthquake, which is estimated to occur in the near future. If anomalous data is observed in the region, JMA will issue information on the Tokai Earthquake.

When an earthquake occurs, JMA issues seismic intensity information in 2 minutes, which announces the occurrence of the earthquake and regions where the seismic intensity is equal to or greater than three in JMA Scale. Subsequently information on the hypocenter and magnitude of the earthquake and cities/towns/villages where a strong shake has been felt is issued.

Since seismic intensity information is directly connected to the expected damages, therefore, this information is used as a trigger for disaster management authorities to take emergency measures.

In case earthquakes occur repeatedly, such as aftershocks of a large earthquake or earthquake swarm events, the number of the earthquakes is also announced.

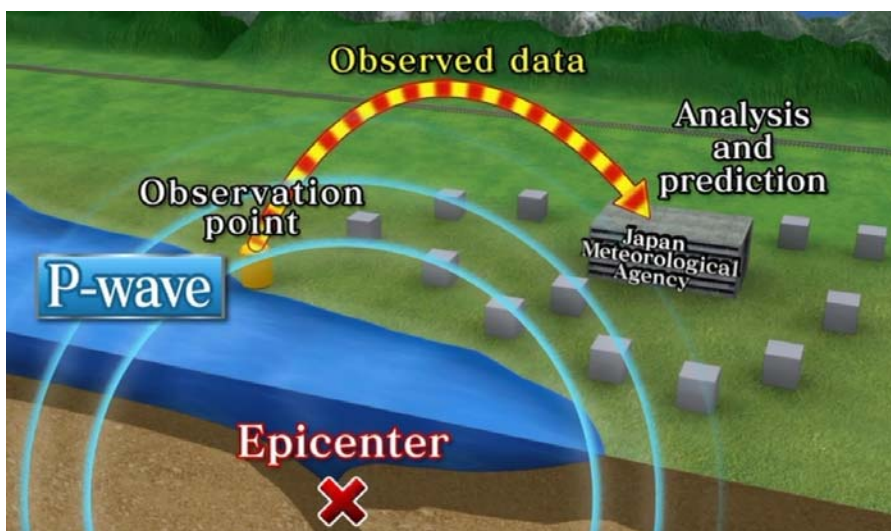

Fig. 25.

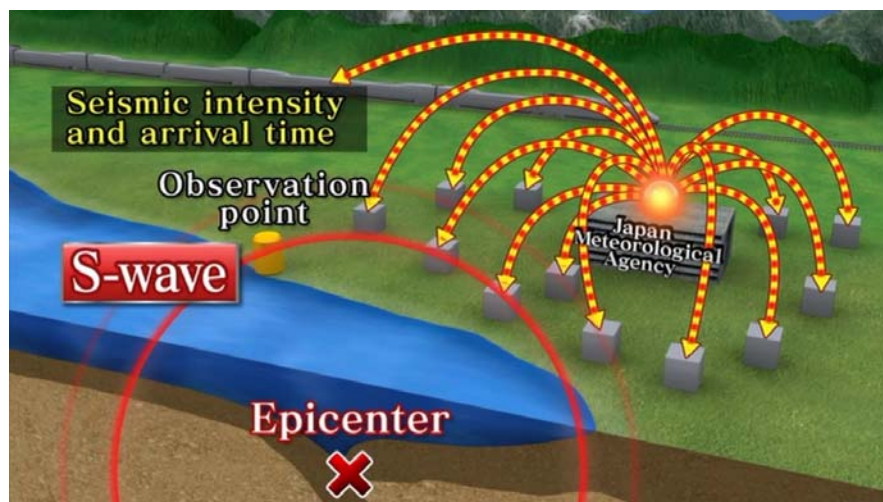

Fig. 26.



Fig. 27.

***Earthquake Monitoring Network.
Seismometer Network.***

JMA operates seismic network, which consists of about 180 seismometers and collects seismic waveform data in real-time around the clock. When a large earthquake occurs, JMA quickly determines hypocenter and magnitude of the earthquake using the collected seismic data and issues tsunami warning and earthquake information.

JMA also collects and analyzes seismic data from universities and disaster management research institutes such as the National Research Institute for Earth Science and Disaster Prevention (NIED) in order to conduct a comprehensive assessment on seismic activities for promotion of research activities in cooperation with the Ministry of Education, Culture, Sports, Science and Technology (MEXT). The products of this analysis are shared with relevant organizations.

JMA Seismic Station



Fig. 28. Communication Facilities in Shelter



Fig. 29. Seismometer and Seismic Intensity Meter in Box

Seismic Intensity Network.

JMA installed about 600 seismic intensity meters throughout the country. In addition, JMA collects seismic intensity data from other 3,300 stations operated by local governments and the National Research Institute for Earth Science and Disaster Prevention (NIED). When an earthquake occurs, JMA promptly issues seismic intensity information based on the data obtained at those stations. The seismic intensity information is used by disaster management authorities as reference for their initial actions in emergency.

2. Early Warning systems and Prevention against natural disaster.



Fig. 30.

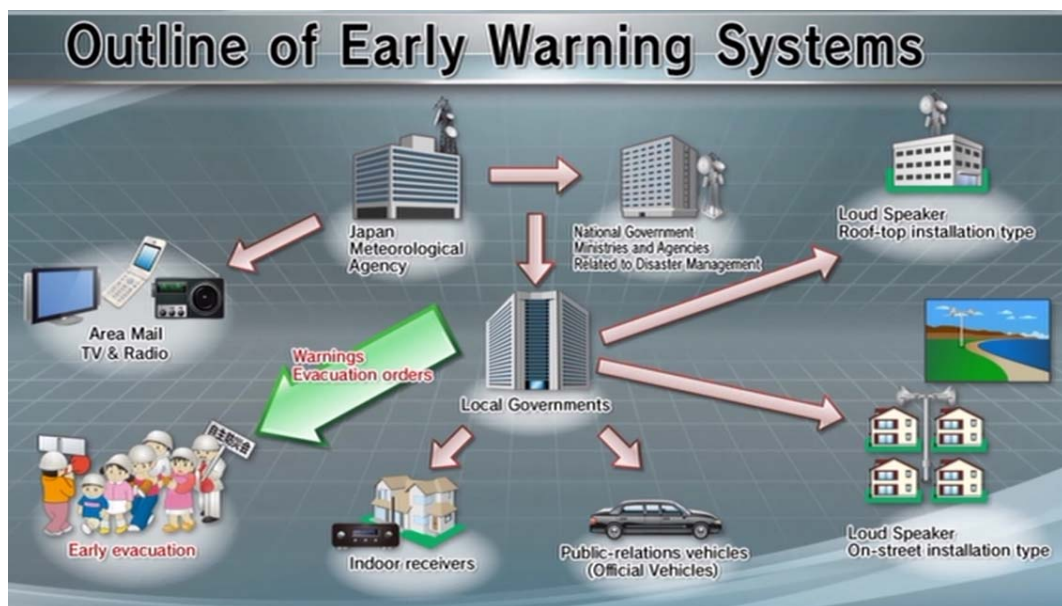

Fig. 31.

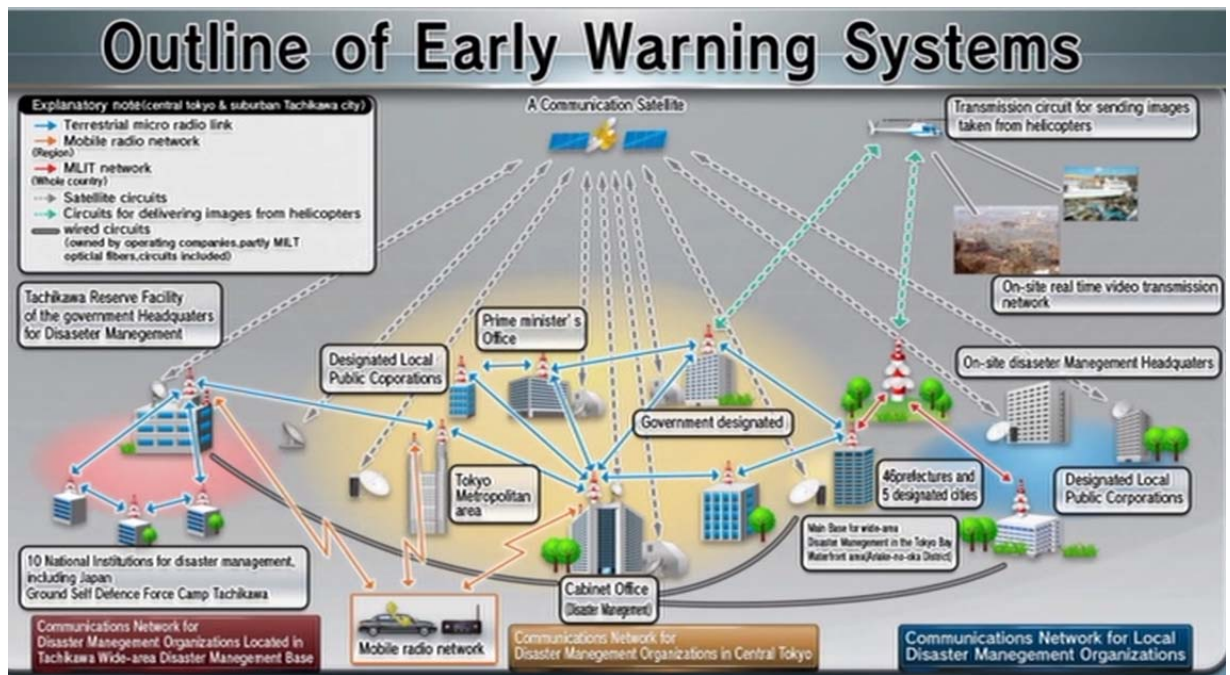

Fig. 32.

3. Response to natural disaster.



Fig. 33.



Fig. 34.



Fig. 35.



Fig. 36.



Police and fire service teams

Fig. 37.



Self-Defense Forces

Fig. 38.



Medical assistance dispatch teams

Fig. 39.

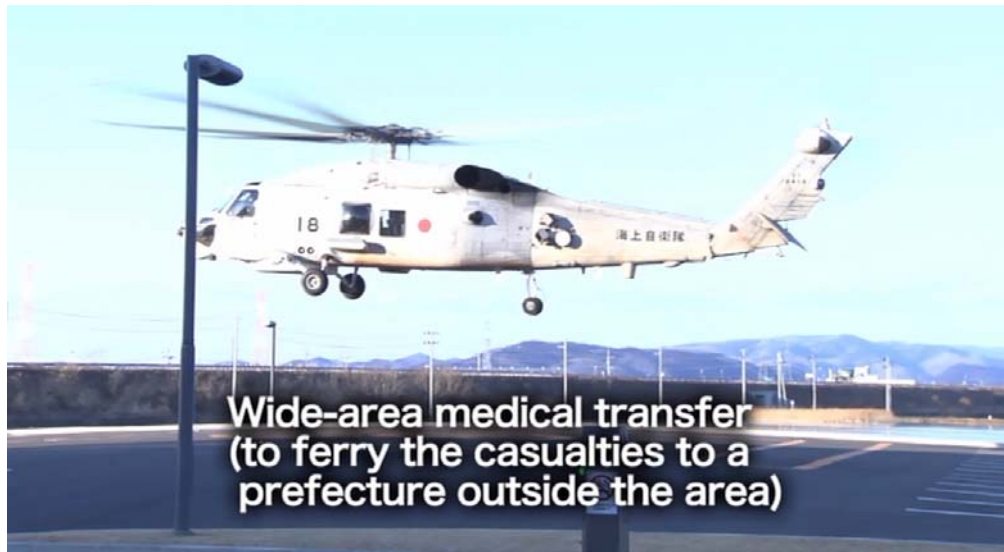

Fig. 40.

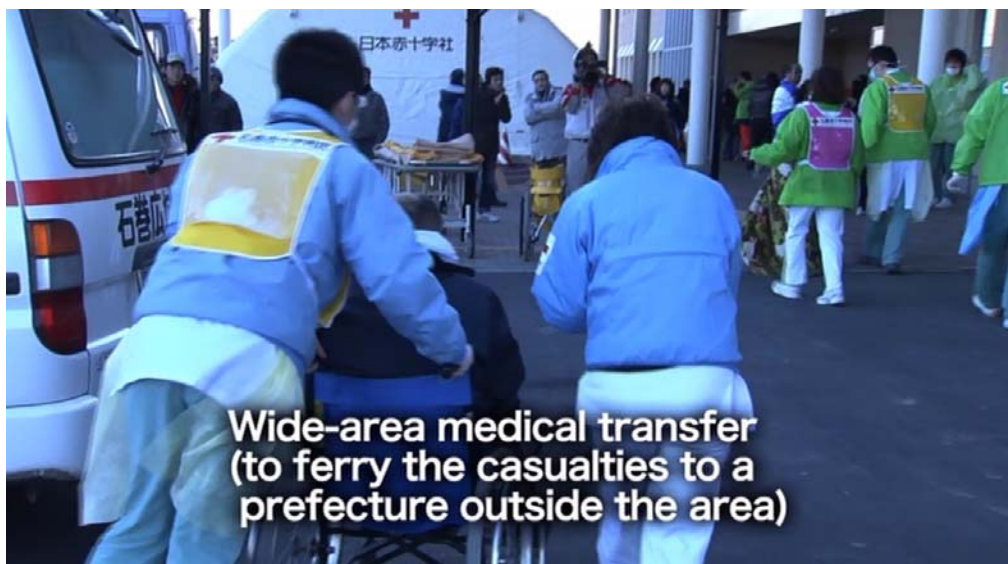

Fig. 41.

4. Recovery and reconstruction.

- Return the affected area to its original state
- Rebuild the lives of the affected people
- Secure housing
- Restore the local economy



Fig. 42.



Fig. 43.



Fig. 44.



Fig. 45.

3.2.5. Future Probable-Disaster and Countermeasure.

Future Issues in Disaster Prevention:

- Electricity and communication were down
- Impaired transmission of information by local authorities
- Unable to protect the coast from a natural disaster beyond imagination
- Difficulty in the transportation of fuel and relief supplies
- Hospital facilities were also damaged and had difficulties in taking in affected people and treating existing patients



Fig. 46.



Fig. 47.



Fig. 48.

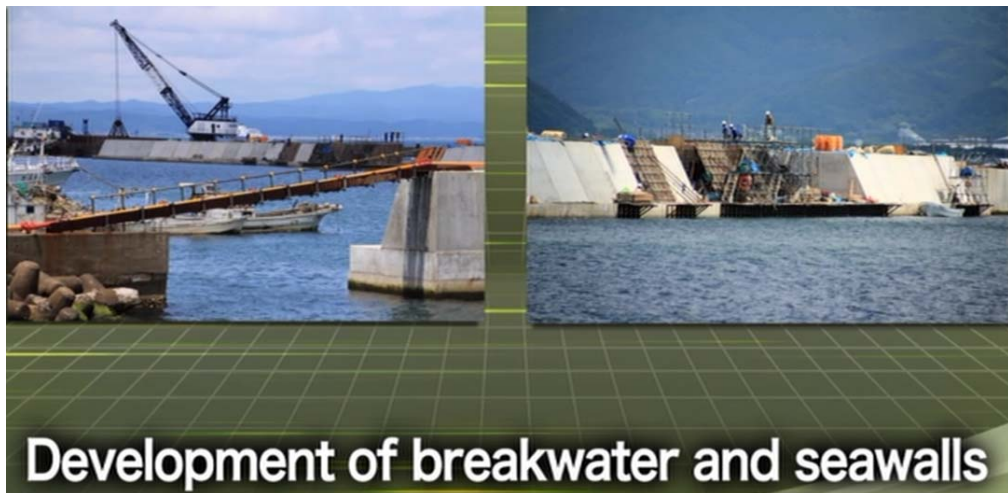

Fig. 49.



Fig. 50.

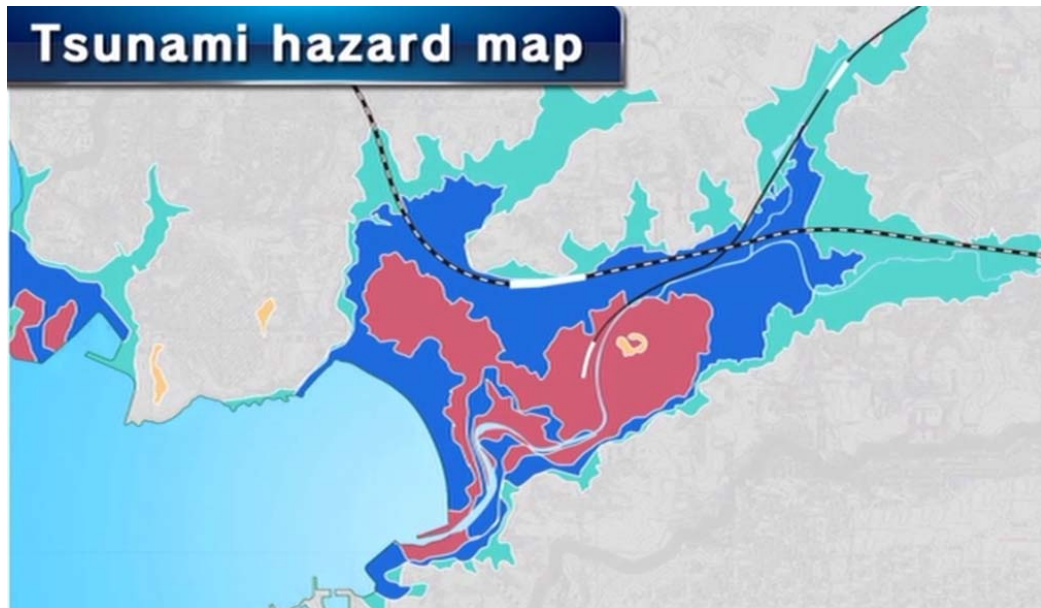

Fig. 51.



Fig. 52.



Fig. 53.



Fig. 54.



Seismic retrofit of public facilities and government related buildings

Fig. 55.



Earthquake-proofing of infrastructure

Fig. 56.



Concrete measures to deal with evacuees and displaced people

Fig. 57.

4. MONITORING LANDSLIDES FOR THE ENSURE THE SAFETY POPULATION IN MOUNTAIN AND FOOTHILL AREAS

4.1. Monitoring Landslides in Uzbekistan.

4.1.1. Activity State Service on Monitoring over the Dangerous Geological Processes.

On the basis of the Resolution of the Cabinet of Ministers Republic of Uzbekistan № 194 in 1994 was established State Service on Monitoring over the Dangerous Geological Processes to monitoring the formation and development of landslides, rock falls, subsidence, suffusion and forecasting of natural and resulting from the economic activity of hazardous geological processes on the territory of the Republic of Uzbekistan in order to warning the local authorities and management of ministries, state committees and departments and other government and economic management of their possible catastrophic forms for decision-making and implementation of activities under the notification of the population, protection of human settlements and economic facilities from the effects of these processes.

Main Tasks of State Service on Monitoring:

- Identification of areas of dangerous geological processes and the evaluation of their activation;
- Organization of monitoring;
- State control of dangerous geological processes;
- Preparation and issuance of recommendations;

Also

- Warning the local public authorities, relevant ministries, state committees and agencies of the possible activation of hazardous processes shall issue recommendations on the organization of observations of dangerous geological processes, and for the State Service on Monitoring is equipped with the necessary means warning, and can use the system alerts the Office Civil Defence

and Emergencies (as agreed with the Head of the Office of Civil Defence and Emergency);

- Gives engineering and geological information about the development of dangerous geological processes, findings and prescriptions for taking action to prevent or mitigate their negative impacts;
- Agree upon to local government authorities, ministries, state committees and departments to current and perspective plans use of territories, including projects for industrial and civil construction, in the areas of dangerous geological processes and issues conclusions about the possibility of their development and other.

4.1.2. The Structure of Monitoring.

The Structure of the State Service on Monitoring consists of the following:

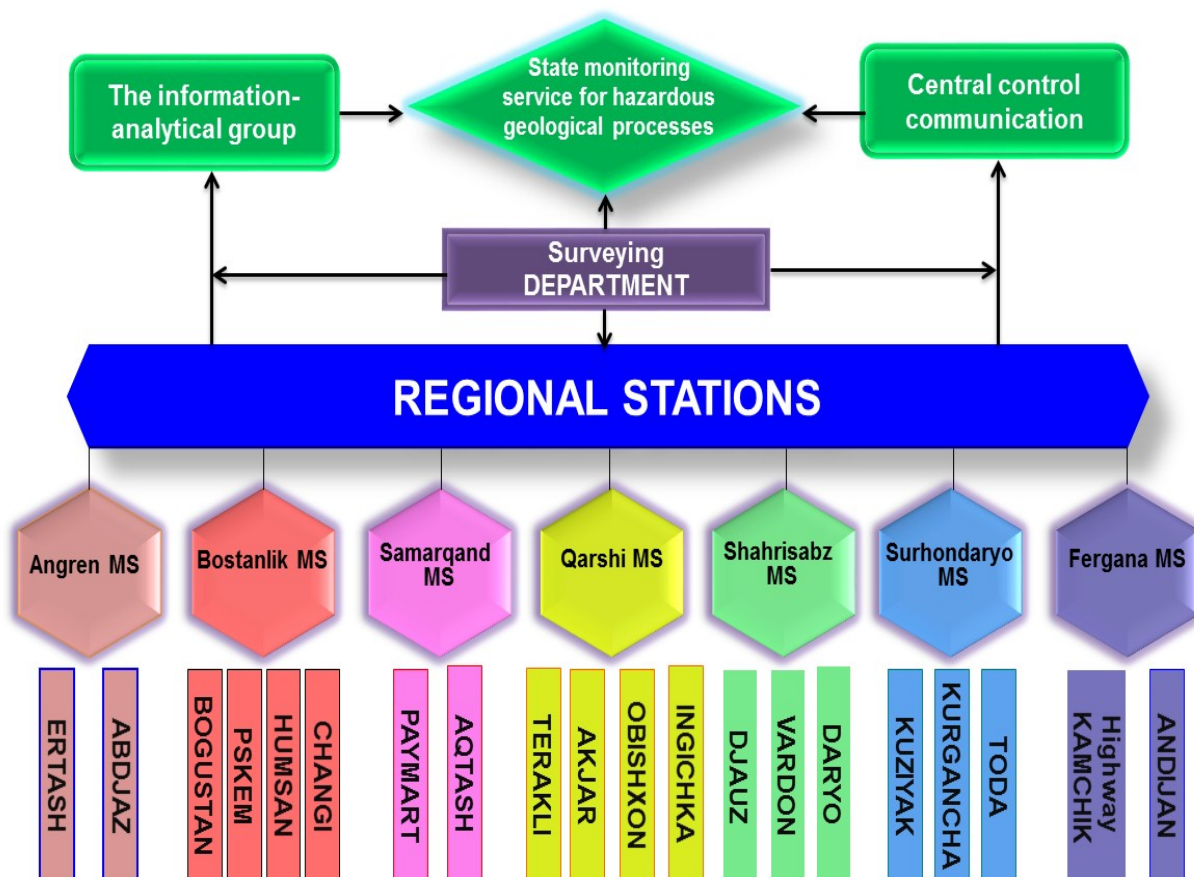

Fig. 58.

Map displays dangerous geological processes in mountain and foothill areas of the Republic of Uzbekistan

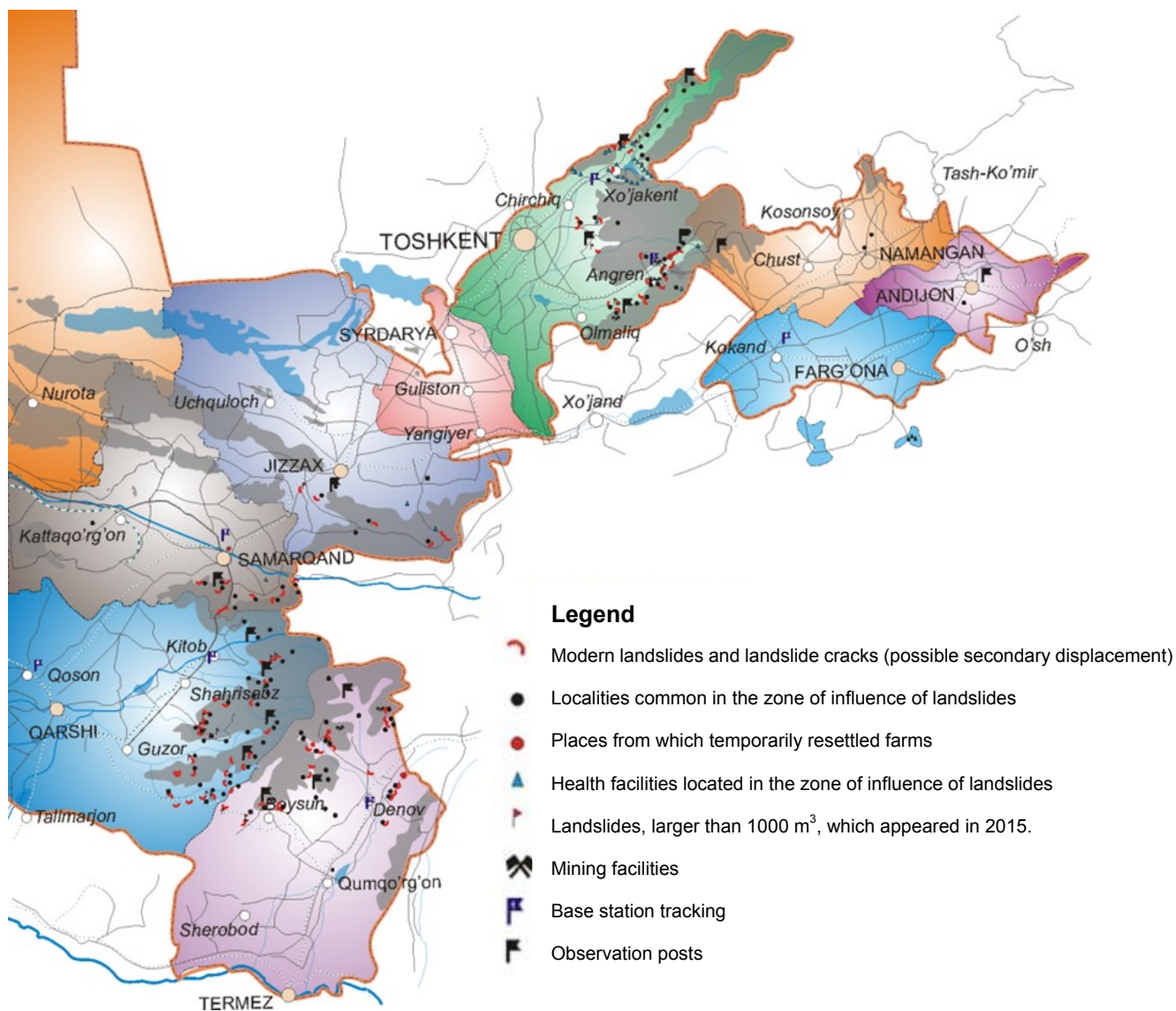

Fig. 58.

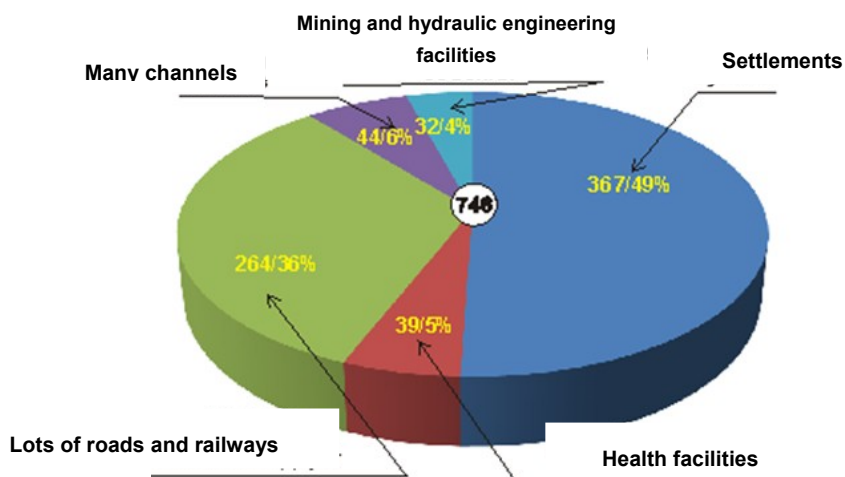

Fig. 59. Figure ratio observation plots

4.1.3. The Structure of the Monitoring System and Warning.

Structure monitoring dangerous geological processes - more attention is not paid to the forecast, and the hazard assessment and the Prevention of process. On this basis, a system of monitoring of dangerous geological processes consists of four blocks:

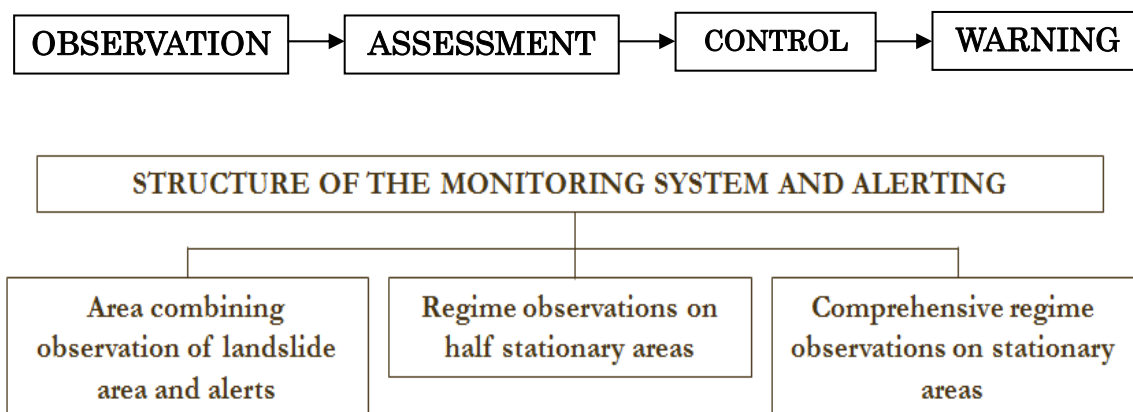

Fig. 60.

Features of Monitoring Landslide.

- Daily transmission of information results observation from monitoring stations to Central Control communication of SMS, where it generalizes forwarded to the Council of SMS;
- Council of SMS reviewed daily results of observations of atmospheric precipitation forecasts, fluctuations in flow rate water springs various trends of landslides and makes the following recommendations;
 - At the most hazardous events immediately sent to information of the Ministry of Emergency Situations and other interested agencies;
 - Practically conducted daily control of the results of observations.

4.1.4. Factors formation of landslides.

The mountain territory of the Republic of Uzbekistan are most susceptible to dangerous geological processes (landslides, avalanches, subsidence, suffusion, karsts). Among them are the highest risk of landslides.

Landslide – slipping and detachment masses of rocks down the slope under the influence of gravity, with the participation of surface and underground water, seismic impact and human activities.

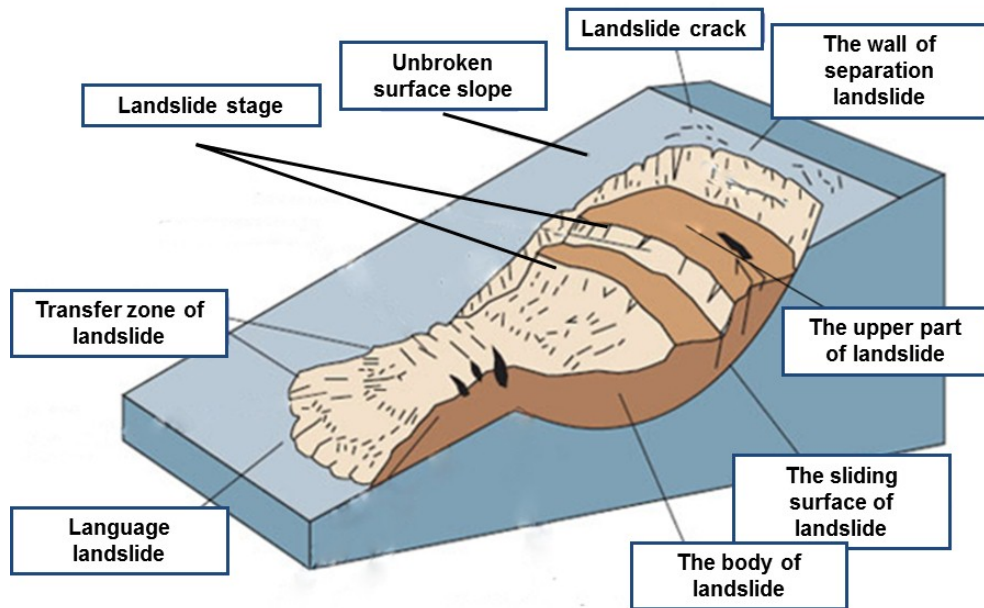

Fig. 61.

Signs landslides on the slopes:

- Cracks on the surface of Earth;
- At the foot of slopes formed by extrusion shaft;
- Between the rollers and bumps under certain conditions, accumulate surface water and groundwater. This causes waterlogging slopes;
- "Drunken trees" and broken tree trunks, as well as the loss of a vertical column of telephone and power lines, fences, walls, etc.;



Fig. 62.

Factors formation of landslides are:

- Meteorological conditions;
- Seismic factors (earthquake);
- Technogenic impact.

Meteorological conditions

#	Types of research	Threshold levels
1	Determination of water content which is expected next spring season	Change of low water on wet years
2	Estimation of rainfall the previous winter period (November or December to February months)	> 500-600 mm
3	Estimation of monthly total precipitation spring (March, April, May)	II-160-200 mm III -170-400 mm IV-140-250 mm V-150 -200 mm
4	Monitoring and evaluation of the daily loss atm. rain for 2-3 days, 5 and 10 days, with a view to timely identification of critical periods and improved the situation	2-3 days >90-110 mm 10 days – 150 -170 mm 15 days → 220 mm
5	Control of the intensity and duration of heavy rain	1 day – 35-50 mm intensity 8-12 mm/hour

Table 2.

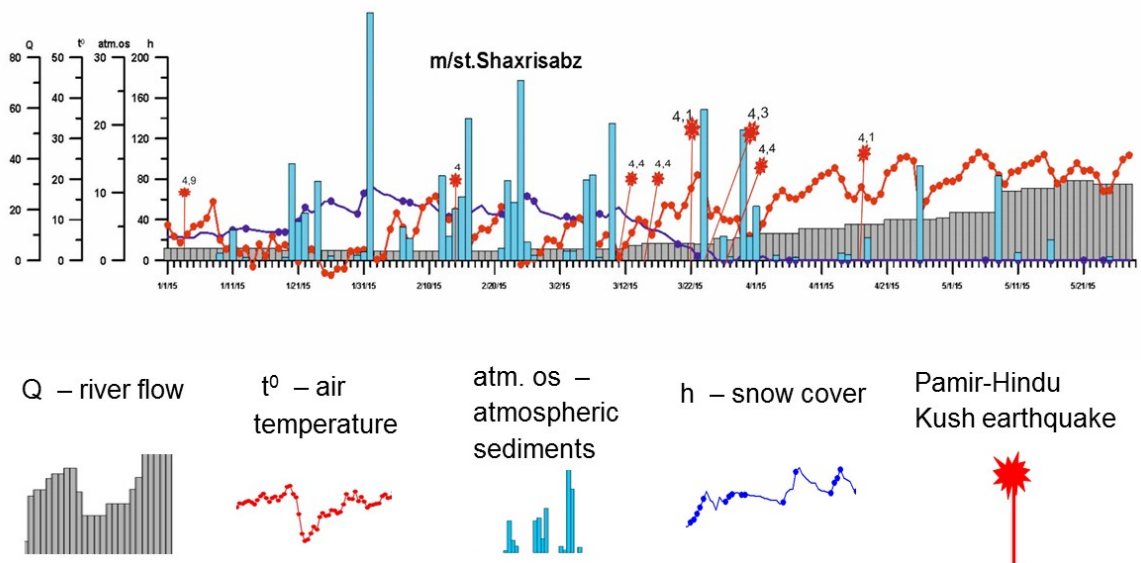

Fig. 63. Combined schedule Snow depth, precipitation, air temperature, river flows and earthquakes in the winter and spring 2015.

Seismic factors of landslides on impact of earthquake.

1. It is a devastating historical earthquake, which are associated with about 65 ancient landslide zones. In these areas there is a relationship inherit places Education today landslides in the circus of ancient seismogravitational residual deformation;

2. Influence of local earthquakes that emerged over the past 50 years is very limited, because they are not deep, and often took place in the autumn;

3. The formation of landslides during and after the strong influence of M - 5,5-7,4, distant (400-500 km), deep (170-230 km), the Pamir-Hindu Kush earthquake zone. These earthquakes in the mountain areas of Uzbekistan in the spring cause long-term low frequency (2 min) fluctuations in saturated soils that form liquefaction, cracked, mud flows;

4. Landslides after earthquake in spring in 3-10 days under influence of precipitation and groundwater.

Table 3. Time of onset of the Pamir-Hindu Kush earthquakes and formation landslide processes in 2015

The time and intensity of earthquakes				Date and place of landslide		
#	Day and month	M	H (km)	Day and month	Name of site	Volume m ³
1	11.03	4,4	88,97	11.03	Djauz	700 th.
2	15.03	4,4	173,8	15.03	BUT M-39 high/way 1316,8-1316,9 km	10 th.
3	21.03	4,9	100	21.03	Pustinlik 2004	2,7 th.
4	24.03	4,3	140,16	24.03	Nondek	5 mln.
5	5.04	4,2	128,14	6.04	Handiza	1,5 mln.
6	11.04	4,3	217,3	11.04	Etimtav	2,6 th.
7	11.04	5,2	217,3	11.04	Zarangbulak	10,8 th.
8	15.04	4,2	94,5	15.04	100,6 km railway T-B-K	11,5 th.
9	17.04	4,1	200,2	17.04	Gushsay	11, 7 th.

Anthropogenic impact on natural environment.

All kinds of engineering-economic impact on geological environment lead to activation of dangerous geological processes.

Areal.

Development of land, industrial zones, etc.

Linear.

Construction of roads and railroads, canals, etc.

Local.

Some local construction in the mountainous area.

4.1.5. Monitoring system landslides.

Monitoring system in Uzbekistan subdivided into three groups:

First – areal monitoring landslide-prone areas to identify new dangerous areas for settlements, recreation, mining and hydraulic structures, roads, canals, water pipelines, transmission towers and other facilities.

Second – Stationary where monitoring of the development of landslide fissures held on extensometer, Mark.

Third – stationary sites, home of the full range of observations of the mechanism of the landslide. Areal monitoring station conducts observations at 750-800 sites.

Aerovisual observation.

Together with representatives of the Uzbek Hydrometeorological Service (Uzhydromet), the Ministry of Emergency Situations and others. Ministries and departments conducted a survey aerovisual mountain and foothill areas of the Republic of Uzbekistan in order to identify new areas and landslide-prone areas, as well as the scale of the landslide threat.



Fig. 64.

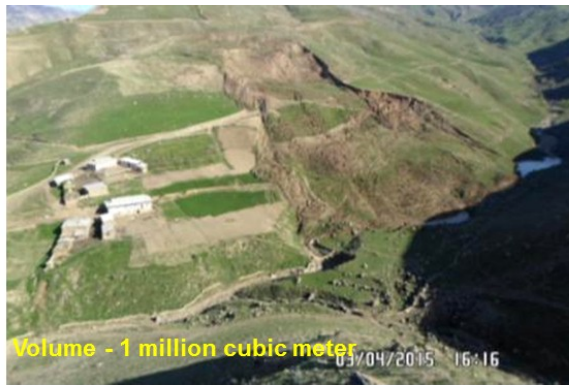

Tegirmonqul, Kashkadarya region

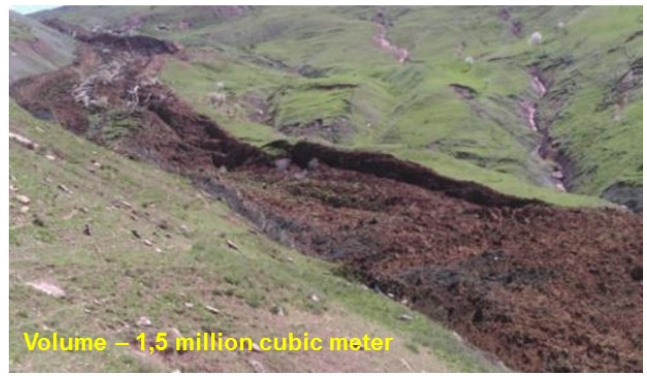

Handiza, Surhandarya region



Chaygul, Kashkadarya region



Nondek, Kashkadarya region

Fig. 65.

Methods for monitoring landslides.

Identifying and study of the areal development of dangerous geological processes performed carrying out route engineering geological studies. The study of the dynamics and mechanism of large landslide carried using high-precision measuring devices of different types.

For the indirect study of the geological structure, water cut landslide arrays are used geophysical methods, such as vertical electrical sensing of using a digital device made in Japan. For the direct study of the geological structure, lithology and water cut of the array landslide performed drilling activity using machine tool company YBM.

The study of the deformation and displacement of landslide dynamics of arrays performed using the method of geodetic satellite navigation (GPS), extensometers, deform meter, inclinometers.

Study of the groundwater level, determining the number and intensity of precipitation, as the main factors contributing to the formation and development of dangerous geological processes performed using electronic gauges and rain gauges in different versions.

GPS method 500 (Switzerland).

Geodetic Satellite Navigation System Leica GPS System 500 (with software SKI-Pro) – the automatic mode, you can get an increment of geodetic coordinates and elevations of points with no direct line your visibility between them in a more operational mode. Technical characteristics GPS receivers can determine the location benchmark accurate to 10 mm, increasing the accuracy of the information about the state of the landslide; GPS receiver receives signals from satellites of NAVSTAR (USA). Software SKI-Pro used for computer processing of field observations performed GPS receiver to determine the baselines of coordinates.

In Uzbekistan, 77 landslides conducted top geodetic observations using GPS.

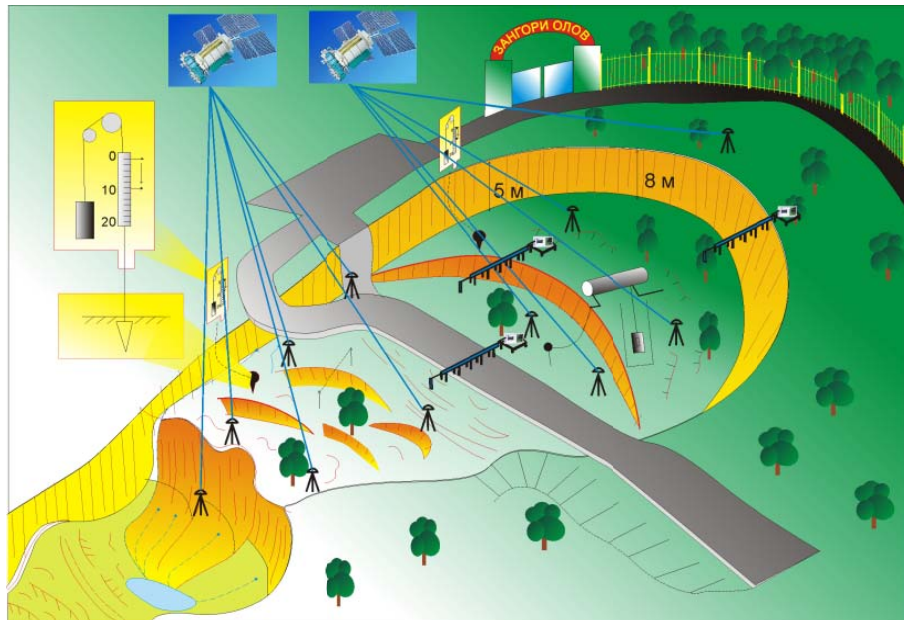

Fig. 66.



Fig. 67. Electronic tachymeter for shooting landslide.



Fig.68. GPS receiver to measure Landslide displacement



Fig. 69. Electronic tachymeter for shooting landslide

Electronic extensometer (Japan).

Electronic extensometer detects the movement of the landslide mass and measures the deformation of cracks as result of activation of the landslide. The device also used to refine the direction of the landslide mass and deformation monitoring, whether due to a large cut slope, bulk works.

Measurement principles are as follows:

Strong piles installed on two points for measuring the deformation cracking. On one side of the crack is mounted extensometer and stretch super Invar wire through the piles installed. Invar wire extensometers coupled to cable wound on the drum extensometer, so that it can expand and contract. On the drum set extensometer recorder, which records the time and length of compression or extension.

In Uzbekistan, eight landslide areas are conducted monitoring observations by electronic extensometer for warning the public and ensure uninterrupted vehicular traffic in National road in the mountainous area.



Fig. 70. Landslide displacement measurement with an automatic electronic extensometer.



Fig. 71. Measurement disclosure landslide cracks using extensometer (SLD).



Fig. 72. Electronic rain gauge (Japan).

Drawing date maps for the development of dangerous geological processes with the use of modern software (ArcGIS, GLOBE Mapper, MapInfo, Micromine and others.) and conducts deep analysis of previously obtained geological, hydrological, meteorological and others. materials.

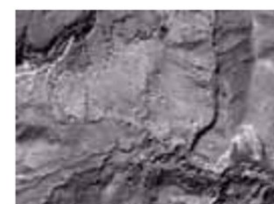
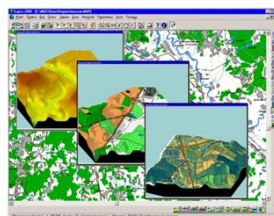
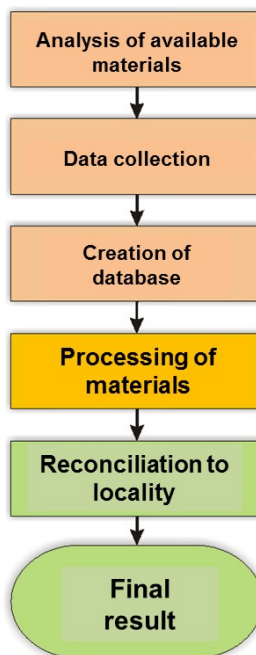
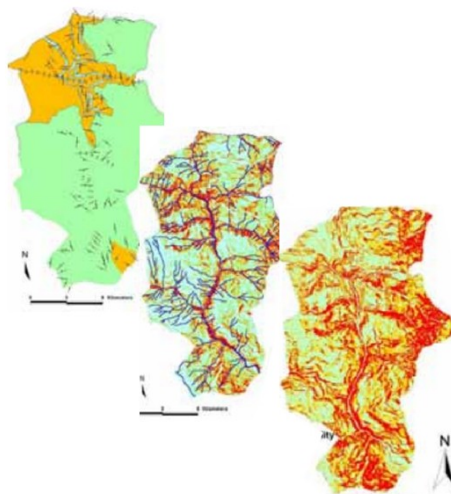

Fig. 73.

Engineering-geological map of zoning conditions of landslides

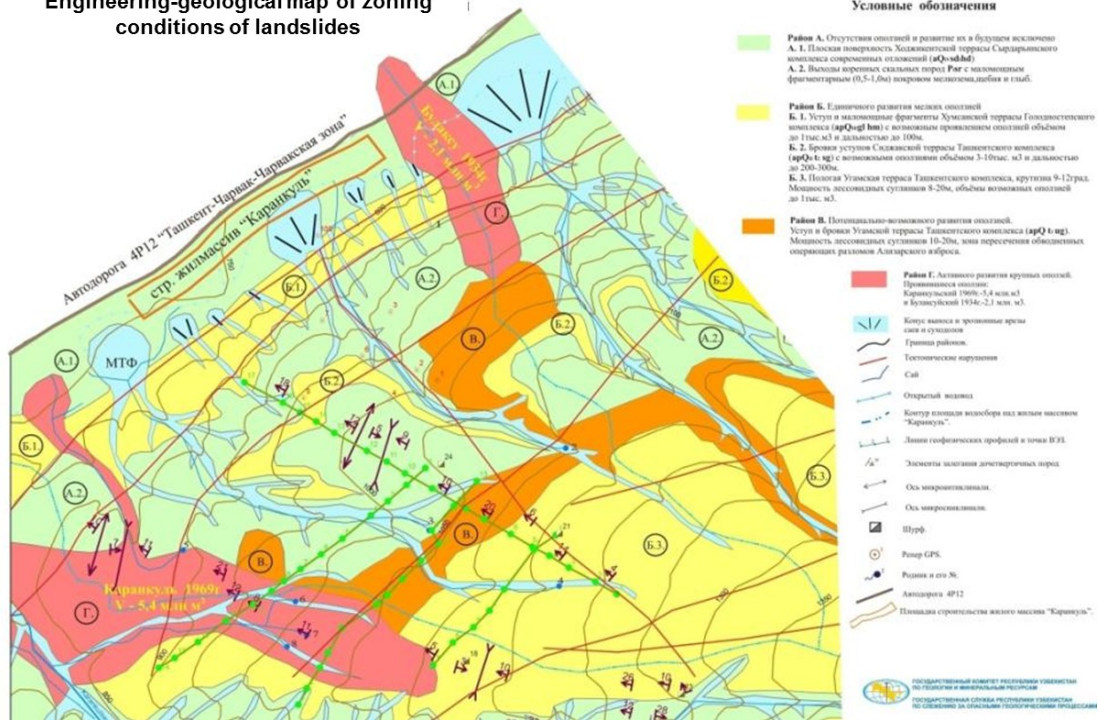

Fig. 74.

Every year are prepared warning information on possible forms of dangerous geological processes for eight regions and one summary of the Republic of Uzbekistan (fig. 75).



Fig. 75.

Anti-landslide measures.

Anti-landslide measures by their nature divided into two groups:

Passive and **active**.

Passive security-related restrictive event:

- ✚ Prohibition of cutting landslide slopes and devices to them all sorts of seizures;
- ✚ Preventing various kinds bedding as slopes and above them within threatening strip;
- ✚ Prohibition of construction on slopes and in these band structures, ponds, reservoirs, objects with large water consumption without performing constructive activities completely eliminates leakage of water into the soil;
- ✚ Prohibition of explosions and mining operations near the landslides;
- ✚ Protection of trees and shrubs and herbaceous vegetation;
- ✚ Prohibition of uncontrolled irrigation of land, and sometimes their plowing;
- ✚ Prohibition of devices and constant column of water aqueduct device without sanitation;
- ✚ Preventing dumping torrential landslide slopes, thawed, sewage and other waters;
- ✚ Moving in landslide areas.

For active, relate landslide events holding which requires a device engineering structures:

- ✚ Retaining structures – to prevent landslides;
- ✚ Retaining walls – relatively small landslides on the slopes in violation of their resistance because of cutting and give a lick and a promise;
- ✚ Pile rows – to strengthen the landslide slopes in the period of temporary stabilization of landslides, with a relatively small (up to four meters) bias power of the body (concrete, reinforced concrete and steel piles are staggered in not biased rock to a depth of 2 m);
- ✚ Solid pile or sheet series (thin walls) (established less other holding facilities because of their high cost).

4.2. Monitoring Landslides in Japan.

4.2.1. About the Japan Landslide Society.

Japan is located at an island arc of Circum Pacific Ocean, which is a Subduction zone. Therefore, Japan has natural conditions characteristic of many volcanoes and frequent earthquakes. In addition, there is much precipitation and most of the land is mountainous. Such geologic, geomorphologic and climate conditions are causing easily landslides which claim precious human lives in every year.

The Japan Landslide Society was established in 1963 in the background of such natural conditions. Later, in August, 1999, this society was approved to be a corporation by Science and Technology Agency. This is only one scientific society dealing with landslides not only in Japan, but also in the world.

Main purpose of the society is “ researching and studying landslides and related phenomena, and countermeasures for preventing such disasters, and acceptance and support funding for studying ” . Main activities of the society are holding technical meetings, educational seminars, and foreign scientist seminars on variable landslides, editing and publishing journals and books, and sending disaster investigation groups etc.

This society organizes annual conference and special symposium every year, and special seminars irregularly. It is issuing bimonthly journal “ Journal of the Japan Landslide Society ” , and “ Landslides in Japan ” introducing landslides of Japan, which is published each several years.

Recently, the Japan Landslide Society consists of 1,600 individual and group members of scientists and engineers from universities, institutes and geologic consultant companies. The specialties are covering wide fields such as geology, geomorphology, soil mechanics, erosion control and civil engineering etc. This society includes Department of General Affairs, Department of Editing and Publication, Department of Event Planning, Department of Research and Study, Department of International Affairs. Besides, in Kyushu, Kansai, Chubu, Niigata, Tohoku, Hokkaido and Kanto, local branches are doing firm-rooted activities (fig 76).

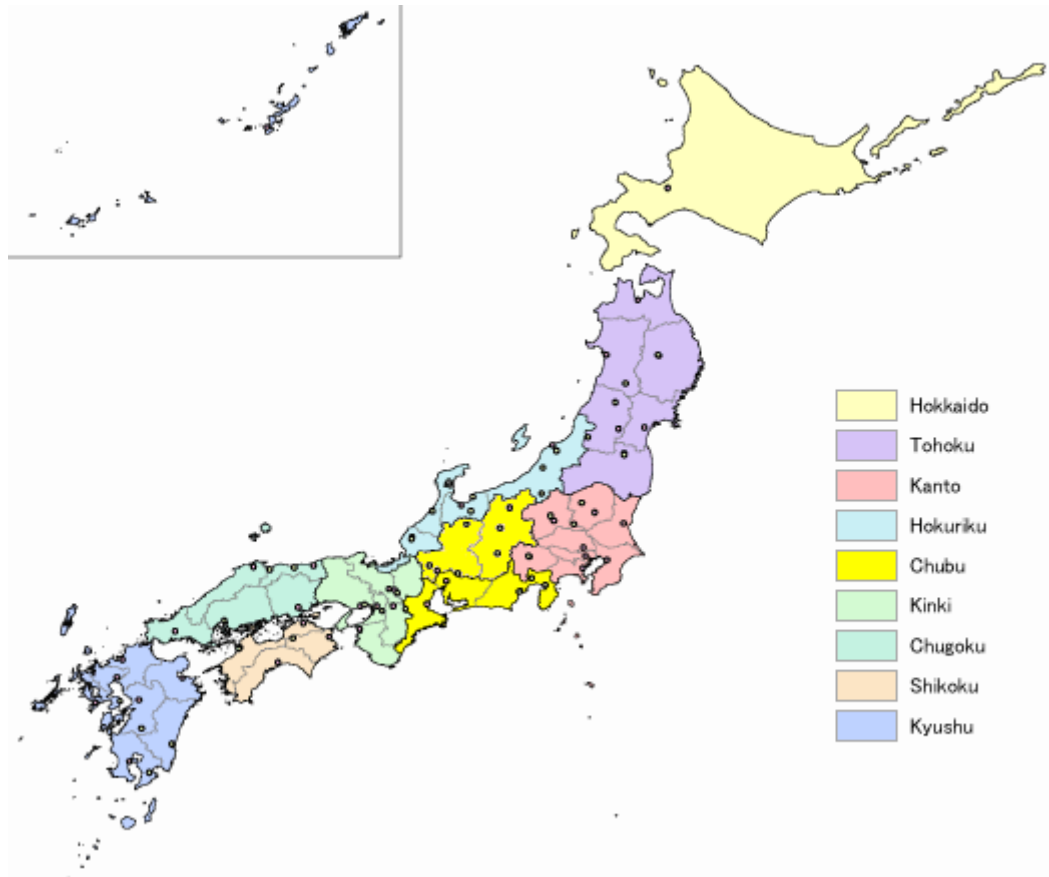

Fig. 76.

A landslide is a phenomenon in which soil mass on a slope moves slowly along the slip surface downward the slope under the influence of ground water and other causes. Since landslides occur over an extensive area and a large amount of soil mass moved in general, it can cause serious damages.

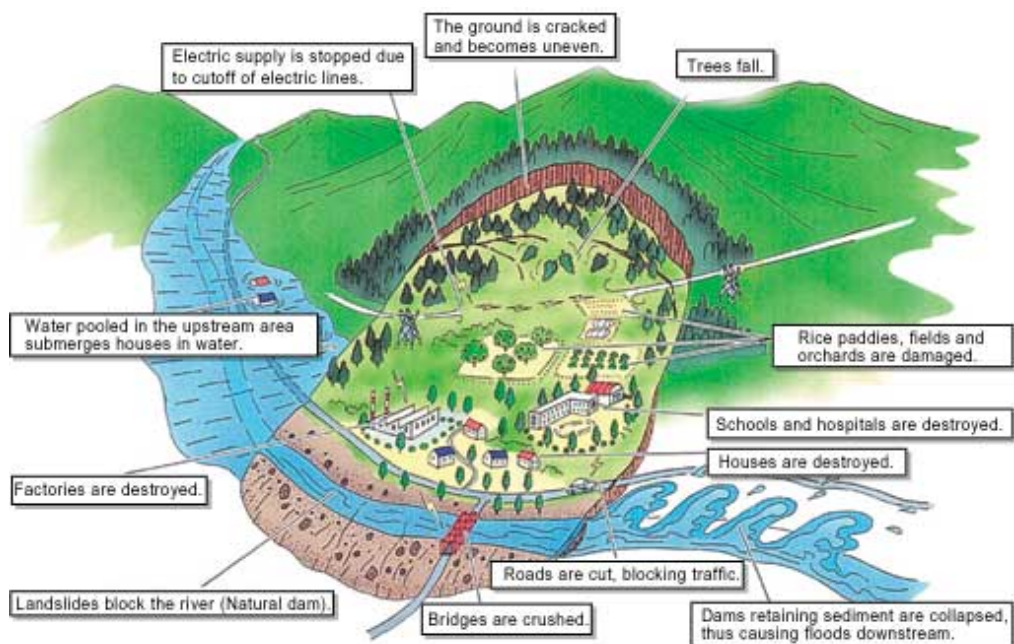

Fig. 77.

4.2.2. Organizational structure

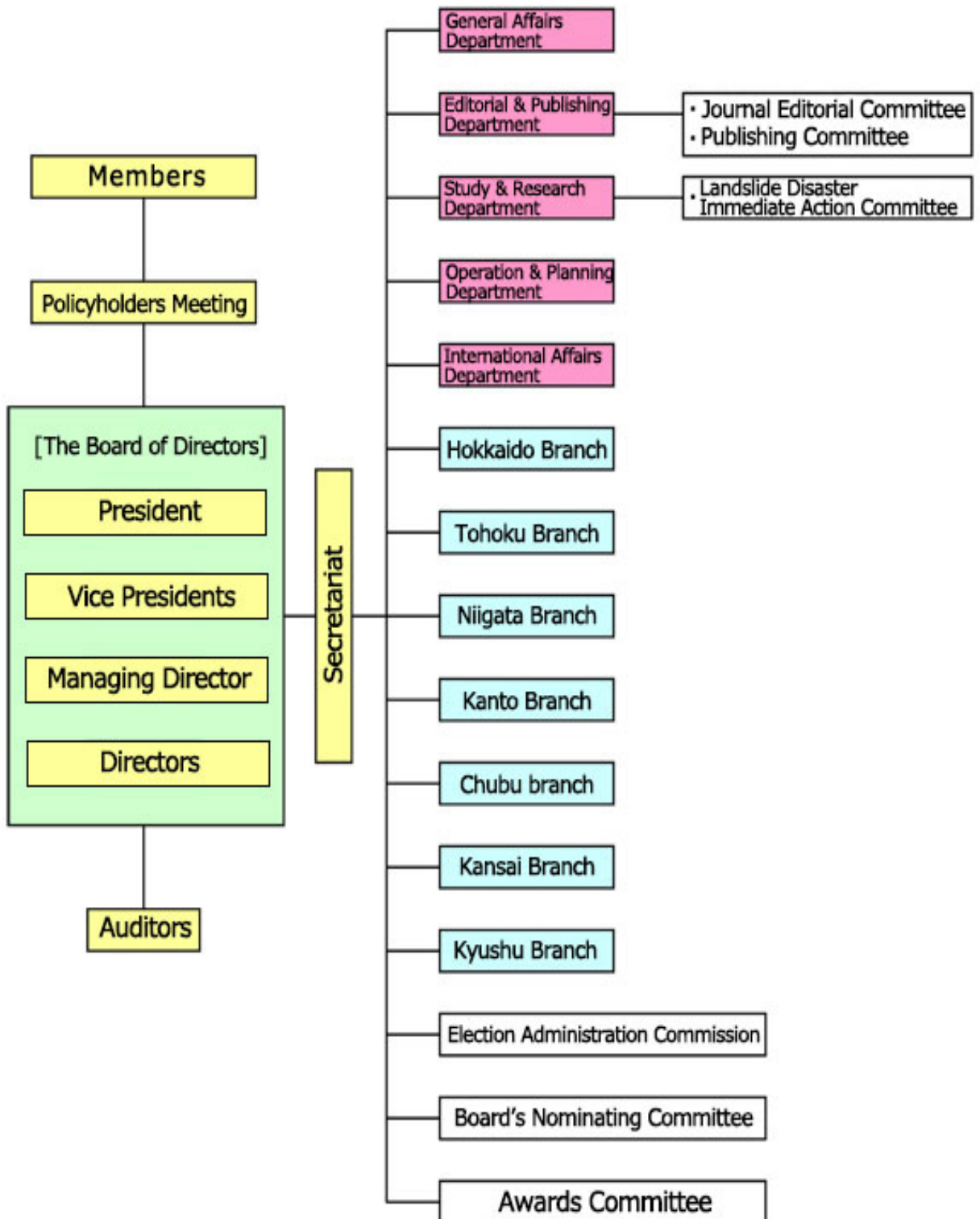

Fig. 78.

4.2.3. Major Landslides in recent years and their impact.

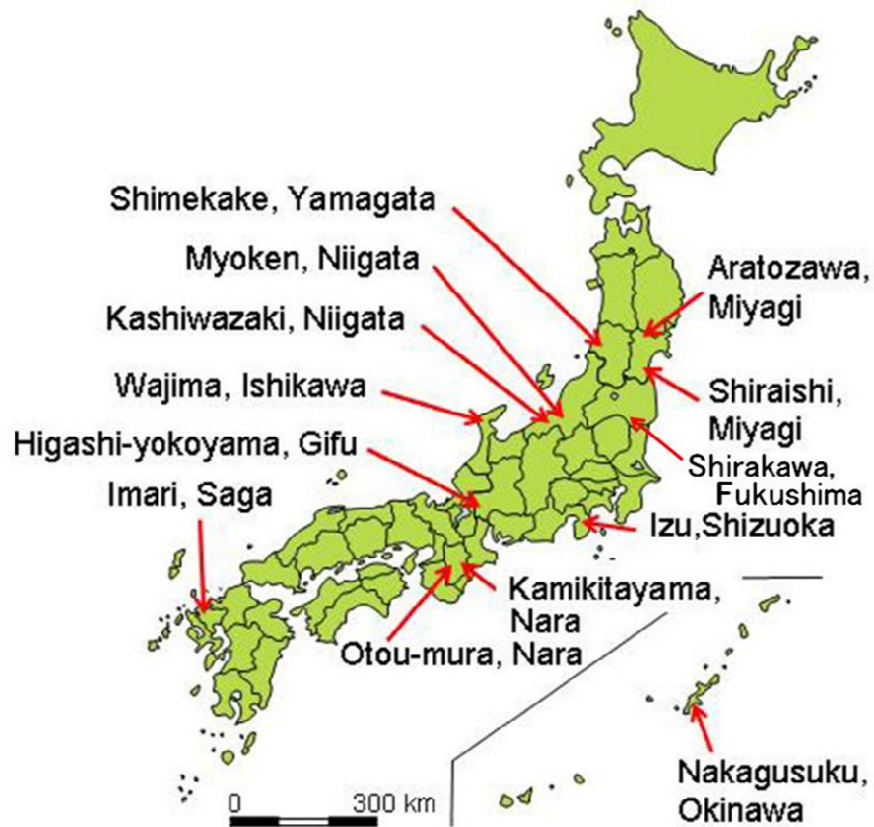

Fig. 79.



Fig. 80. Tohoku-Taiheiyo Earthquake, Shirakawa, Fukushima (March 2011)



Fig. 81. Hiroshima (August 20, 2014)



Fig. 82. Shimekake, Yamagata(Jun 2009)



Fig. 83. Aratozawa, Miyagi (Jun 2008)



Fig. 84. Kashiwazaki, Niigata (Jul 2007)



Fig. 85. Kamikitayama, Nara (Jan 2007)



Fig. 86. Wajima, Ishikawa (Mar 2007)



Fig. 87. Nakagusuku, Okinawa (Jun 2006)



Fig. 88. Imari, Saga (Sep 2006)



Fig. 89. Higashi-yokoyama, Gifu (May 2006)



Fig. 90. Myouken, Niigata (Oct 2004)

Table 4. The impact of disaster: number of Dead and Missing

Year	Slope Failure	Debris Flow / Landslide	Flood / Others	Snow Avalanche	Total
1967	158	297	152	0	607
1968	5	154	100	0	259
1969	82	32	69	0	183
1970	27	22	114	0	163
1971	171	53	126	0	350
1972	239	194	154	0	587
1973	18	19	48	0	85
1974	129	40	155	0	324
1975	49	71	93	0	213
1976	81	72	120	0	273
1977	8	12	154	0	174
1978	23	16	114	0	153
1979	23	4	181	0	208
1980	25	0	123	0	148
1981	20	13	185	14	232
1982	185	152	187	0	524
1983	78	29	193	1	301
1984	16	29	149	5	199
1985	15	41	142	1	199
1986	26	4	103	15	148
1987	4	3	62	0	69

1988	12	17	64	0	93
1989	15	14	67	0	96
1990	19	32	72	0	123
1991	12	55	123	0	190
1992	3	0	16	0	19
1993	141	33	264	0	438
1994	0	0	39	0	39
1995	8	38	120	0	166
1996	4	14	65	1	84
1997	10	21	40	0	71
1998	12	9	88	0	109
1999	17	17	107	0	141
2000	6	0	72	0	78
2001	2	2	86	0	90
2002	2	2	44	0	48
2003	2	21	39	0	62
2004	28	34	248	0	310
2005	8	22	229	1	260
2006	7	18	152	0	177
2007	0	0	41	0	41
2008	6	14	81	0	101
2009	5	17	93	0	115
2010	3	8	69	9	89
2011	9	76	19908	0	19993*
2012	9	15	168	0	192
2013	6	47	120	0	173
2014	9	72	-	0	-

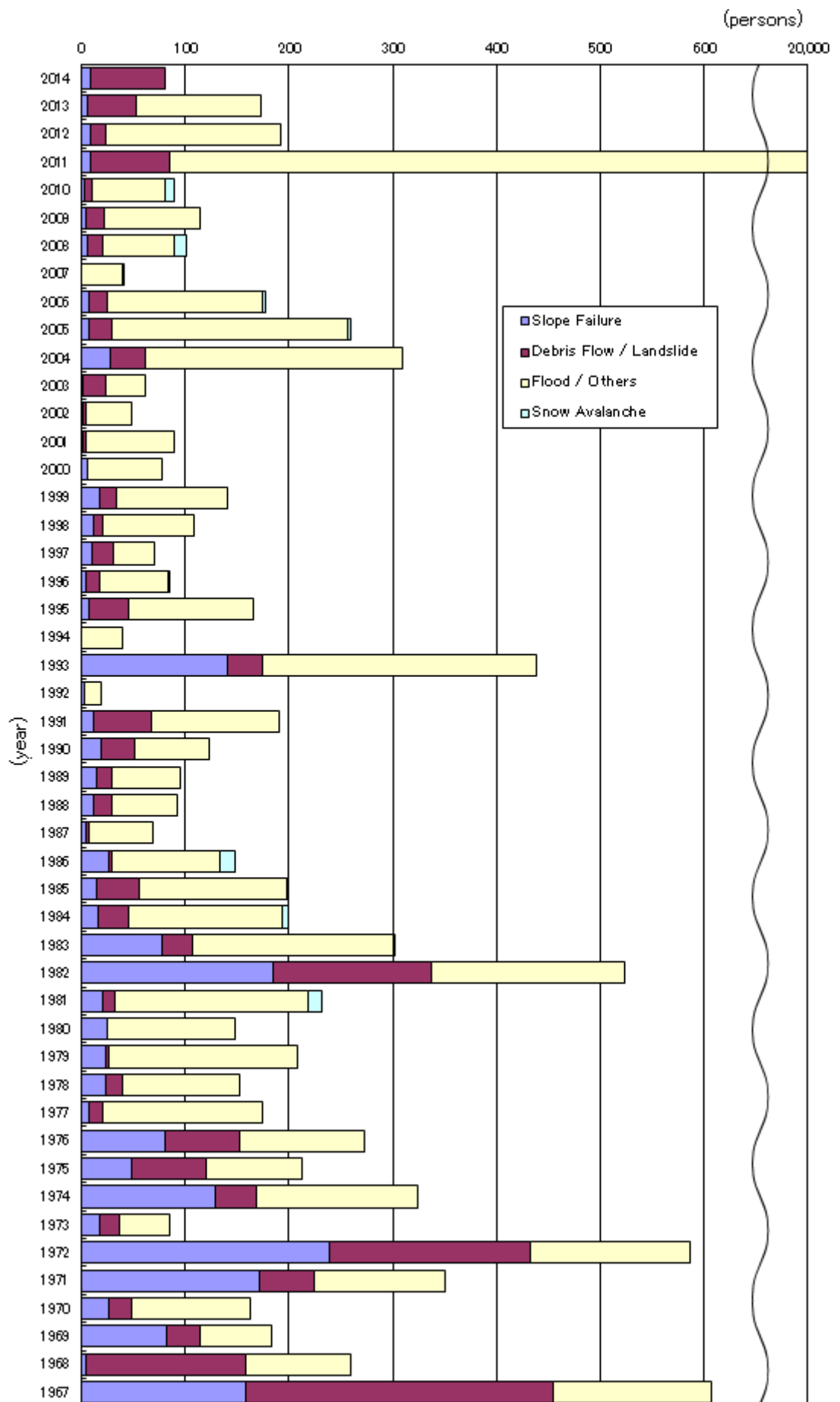

Fig. 91.

Table 5. The Number of Disaster Occurrence.

Year	Debris Flow	Slope Failure	Landslide	Total
1982	293	1567	147	2007
1983	352	1093	119	1564
1984	67	103	51	221
1985	165	538	145	848
1986	104	356	102	562
1987	165	186	70	421
1988	181	291	102	574
1989	200	345	111	656
1990	238	852	180	1270
1991	2879*	599	122	3600
1992	4035*	232	55	4322
1993	2288*	1413	171	3872
1994	853	142	68	1063
1995	309	347	237	893
1996	91	258	64	413
1997	101	917	136	1154
1998	317	1160	152	1629
1999	373	960	168	1501
2000	180	291	137	608
2001	48	365	96	509
2002	46	275	218	539
2003	57	712	128	897
2004	565	1511	461	2537
2005	158	483	173	814
2006	169	1057	215	1441
2007	129	675	162	966
2008	154	452	89	695
2009	149	803	106	1058

2010	234	767	127	1128
2011	419	781	222	1422
2012	256	505	76	837
2013	262	590	89	941
2014	338	769	77	1,184

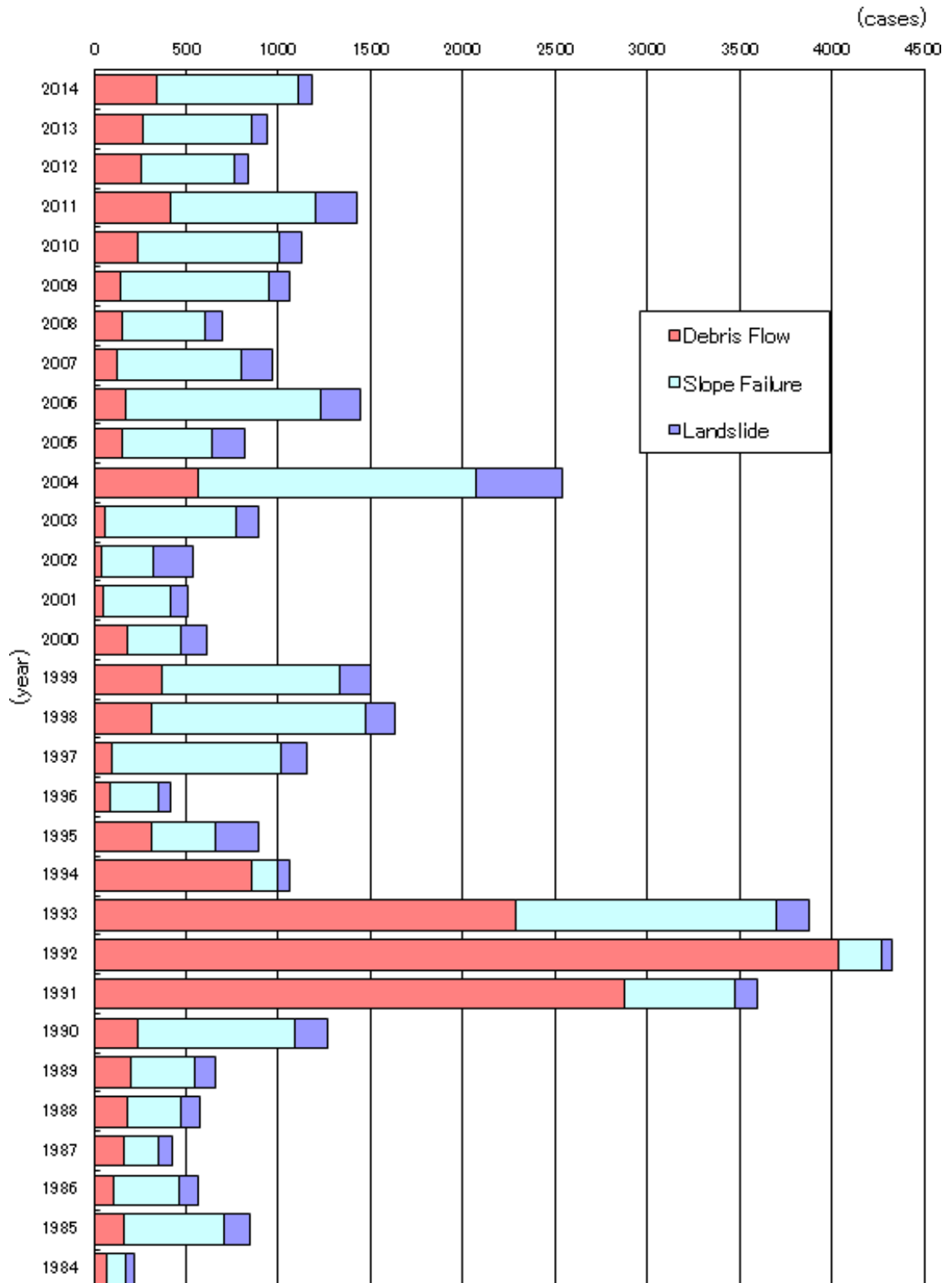

Fig. 92.

4.2.4. New methods of monitoring landslides and maintaining them in a stable state.

Two third of the Japanese Archipelago is dominated by mountains; 100 million people are forced to live and work in slopes or around slopes. Landslides often cause disasters and cause extensive damage.

In this regard, research organizations and universities to carry out research work on the study and prevention of landslides. Also conduct monitoring of landslides and develop new designs to maintain a steady state of landslides.

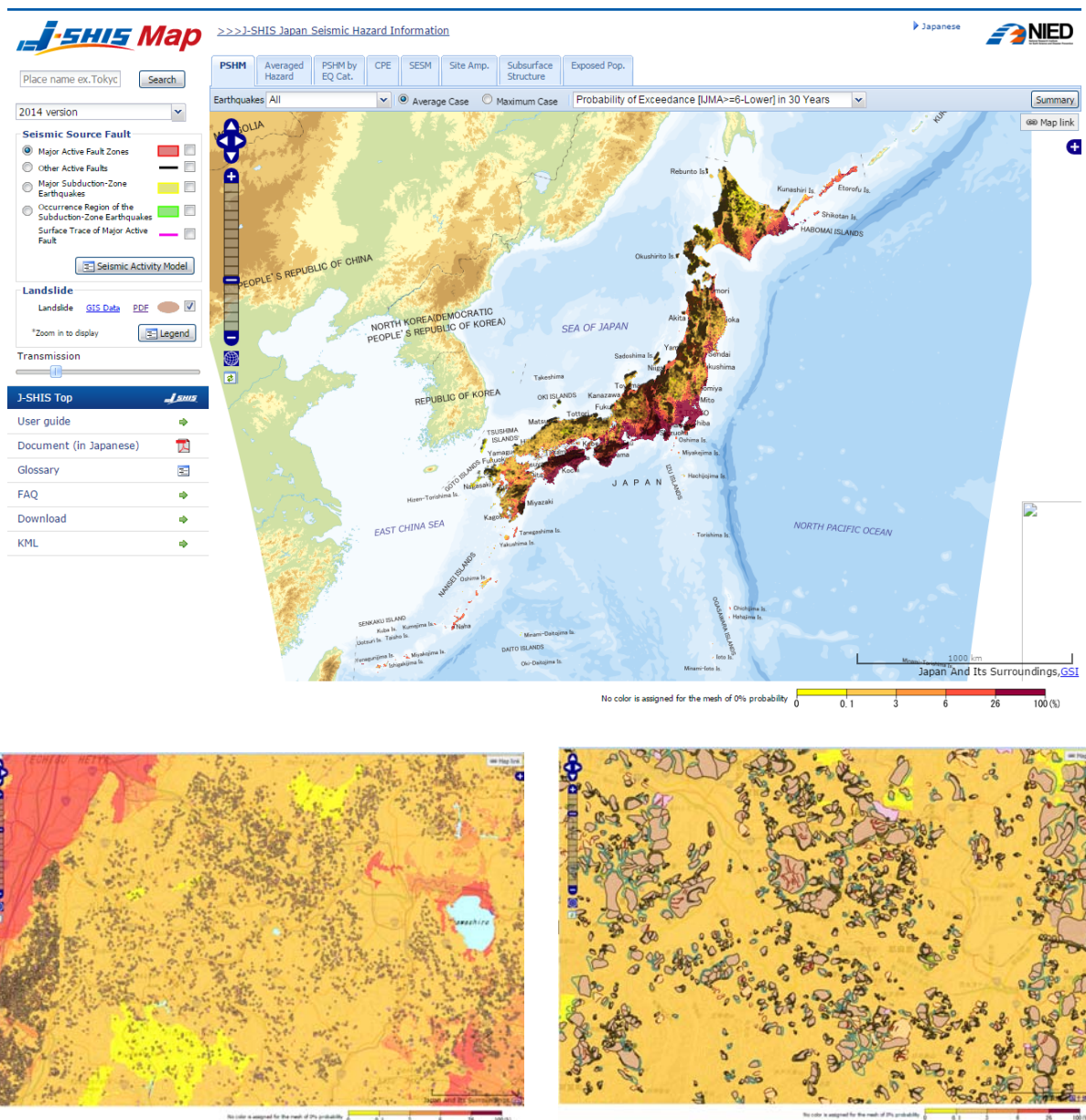



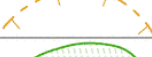
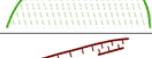

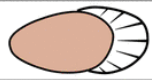



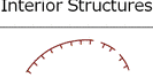

Fig. 93. Map of landslides.





Boundary Structures
Main scarp and lateral scarp(flank)

	Main and/or lateral scarp of which crown is fresh or not dissected
	Partially dissected crown
	Mostly dissected crown
	Roundly subdued and vague crown
	The missing part of the scarp and crown by dissection.
	Exposed slide surface without sharp scarp.
	Lunar or crown cracks, multiple scarps and ridges.



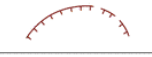
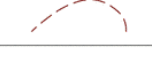
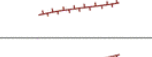

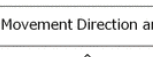

Boundary Structures
Margin of moving mass

	Definite margin of the moving mass
	Indefinite margin of the moving mass
	An area unstable mass is remained
	A part of margin overlain by another moved mass or deposits
	Probable boundary of an area inferred as an unstable or quasi-moving mass
	A mountain or hill difficult to identify whether mass is moving or not

Interior Structures

	Secondary scarp: The crown is similarly shown in a main scarp
	Boundary between sub-units or an interior moving/moved mass
	Ridge (interior)
	Wide trench or open crack
	Narrow trench or open crack
	Echelon cracks
	Linear depression or valley floor line. Arrow shows the downstream

Movement Direction and Main Moving Direction of the Mass

	Slide
	Creep
	Flow
	Fall
	Slow movement with external rotation
	Dip of the move slope surface. Usually shown in case of reverse dip from original slope

Centroid

	Centroid of moving mass
---	-------------------------

Fig. 94. The legend for map of landslides.

Preventive measures against landslide.

A landslide is caused by a combination of various factors (topography, geology, geological structure, ground water, etc.). Accordingly, measures to be taken for landslide prevention come in a variety of types. Broadly the landslide preventive measures are classified into two types of works: control works and restraint works.

The control works are intended to remove or mitigate factors which may lead to the occurrence of a landslide. On the other hand, the restraint works aim at stabilizing a slope by the construction of structures. Landslide-prone slope is effectively stabilized by the combination of both types of works.

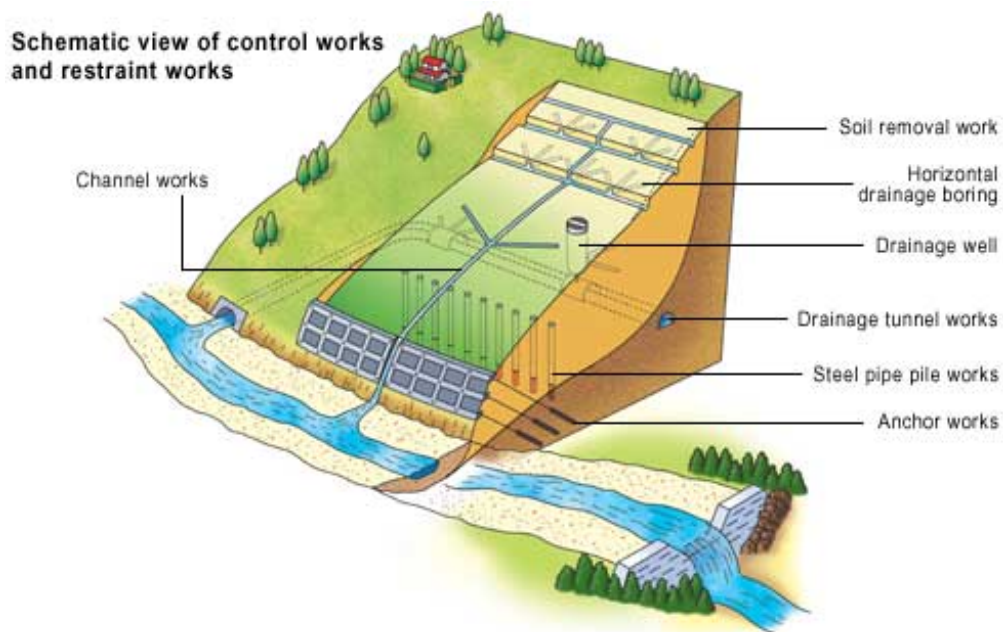

Fig. 95.

4.2.4.1. New nailing network system.

Japan, topography, geology, from the social conditions of the natural conditions and land use, such as weather, is a leading slope disaster zone in the world. Therefore, so far has been developed various disaster prevention method

In recent years, with increasing awareness of the environment and landscape, also for slope stabilization measures, there is a growing interest in the construction method of conservation taking advantage of the green on the slopes.

"Non-frame construction method" is, as a new slope stabilization method that meet the demands of this era.

Non-frame construction method reinforcing material (rock bolts), Bearing plate. Head consolidated material consists of (wire rope).

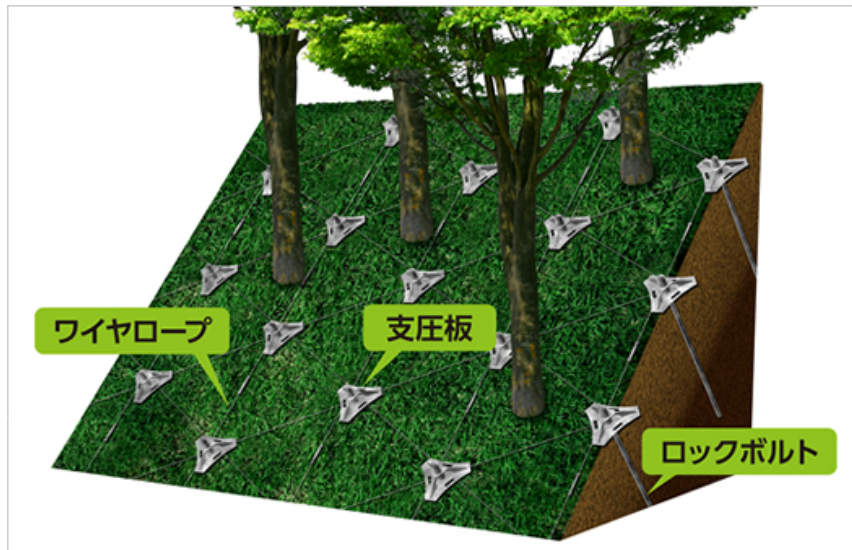

施工イメージ図(CG)

Fig. 96.

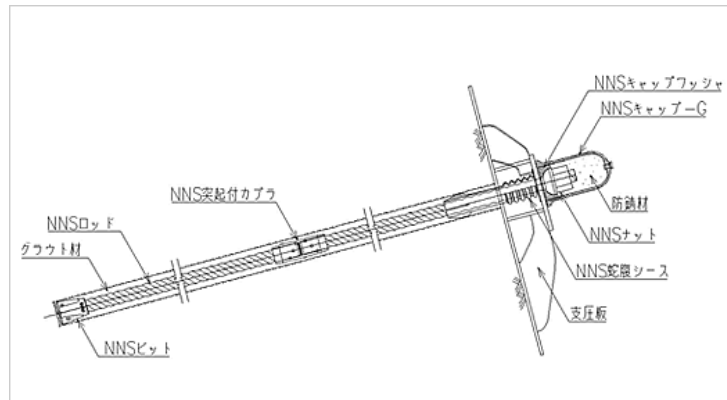

構造断面図 (自穿孔方式の場合)

Fig. 97.

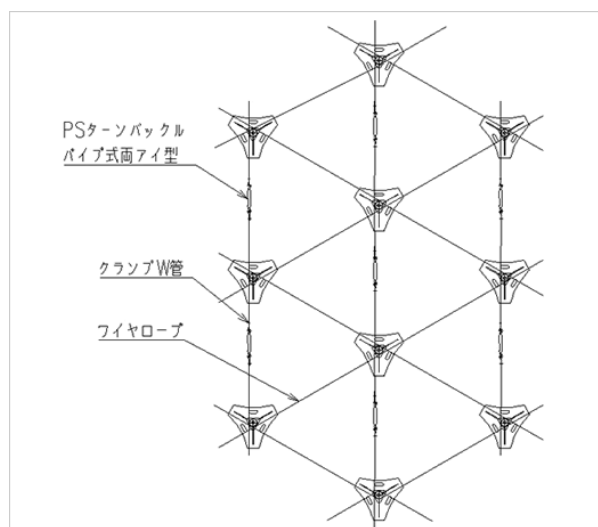

構造平面図

Fig. 98.

It has become a double corrosion protection structure over the reinforcement length. On request, such as landscape protection, it will be able to paint a member, which exposed to the earth's surface.

Used material.

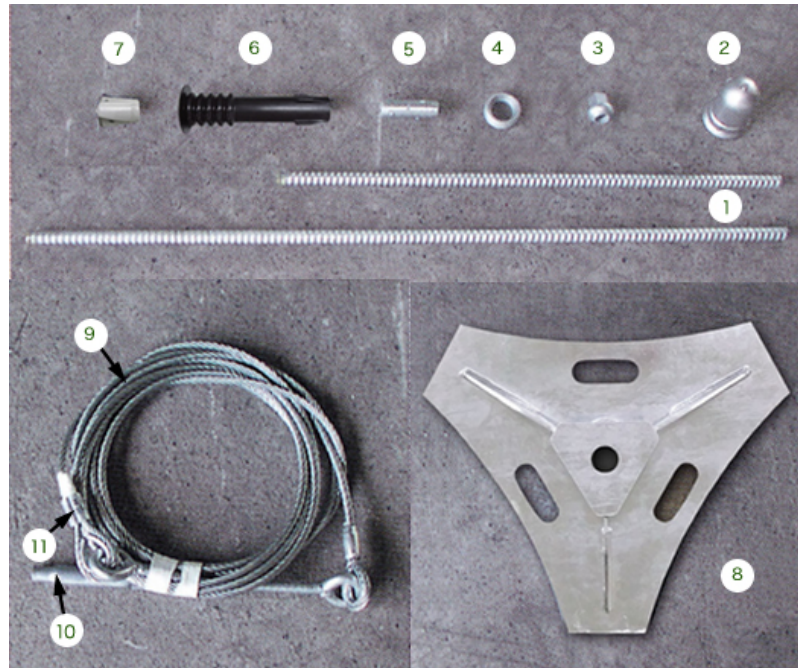

Fig. 99.

Table 6.

#	Name	Material	Standard	Surface treatment
1	NNS rod	S45C equivalent	JIS G 4051 Mechanical structural carbon steels	Hot dip galvanizing HDZ55
2	NNS cap – G	ADC12 equivalent	JIS H 5302 Aluminum alloy die-casting	-
3	NNS nut	FCAD900-8 Substantially	JIS G 5503 Austempered spheroidal graphite cast iron goods	Hot dip galvanizing HDZ55
4	NNS Cap washer	FCAD900-8 Substantially	JIS G 5503 Austempered spheroidal graphite cast iron goods	Hot dip galvanizing HDZ55

#	Name	Material	Standard	Surface treatment
5	NNS with projection coupler	FCAD900-8 Substantially	JIS G 5503 Austempered spheroidal graphite cast iron goods	Hot dip galvanizing HDZ55
6	NNS bellows sheath	NBR equivalent	Synthetic rubber	-
7	NNS bit	S45C equivalent	JIS G 4051 Mechanical structure for carbon steel	-
8	Bearing plate	SS400	JIS G 3101 General structural rolled steel	Hot dip galvanizing HDZ55 (Necessary plating rear coating also available)
9	Wire rope	SWRZA	JIS G 3525 G species equivalent	Alloy plating Zn + 10% Al + Na
10	PS turnbuckle Pipe type	Frame portion STKM11A	JIS G 3445 Carbon steel pipe for mechanical structure	Hot dip galvanizing HDZ35
		Eyebolt SS400	JIS G 3101 General structural rolled steel	
11	Clamp W tube	ADC12	JIS H 4000 Aluminum alloy	-

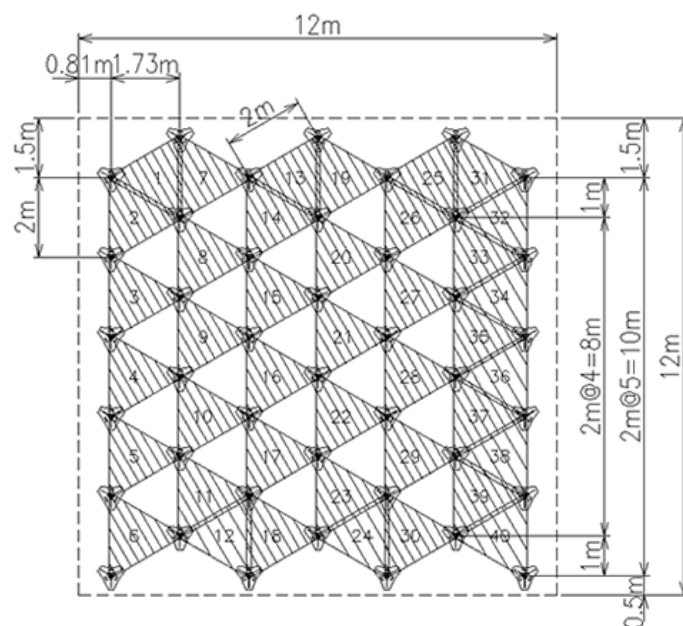

Fig. 100. Standard layout.

Wire rope Masu mounting three lock bolt in one so that the triangle. Digits and the hatching in the figure shows the mounting position of the wire rope.

Construction interval of the lock bolt, it may also be shortened by soil conditions.

Construction process.

1. Positioning Engineering.

Principles of positioning (each control value in the case of standard punch set interval (2.0m pitch)).

1. Drilling position is the length of one side is l be placed on a slope so that the equilateral triangle of 2m.
2. As drilling position and perpendicular to the contour.
3. There is an obstacle to the drilling position, when the Bearing plate cannot be installed, and moving the drilling position to the location where the length of one side of the triangle does not exceed 3m.
4. Three sides total length of the triangle does not exceed 7m.
5. It should be noted that, depending on the size of the obstacle, if the total length of the three sides of the triangle is more than 7m, I add strokes set a reinforcing material.



Fig. 101.

2. Scaffolding Engineering.

Basic scaffold assembly.

1. Scaffold local conditions, to determine its structure in consideration of the drilling machine and the like.

2. Work floor area of 4m² or more is desirable.
3. The scaffolding I to ensure always provided safe fall prevention fence.
4. Even trees hinder scaffolding assembly; in principle, logging not performed.



Fig. 102.

3. Drilling Engineering.

Basics of drilling.

Drilling machine is a standard the Regguhanma (auxiliary rail Su~ibe Le combination), taking into account topography, geology, vegetation, the drilling length, etc., and to select a drilling machine of suitable capacity.

However, if the scaffold assembly to adopt a difficult and unavoidably rope scaffold, but carry out the drilling in Regguhanma alone, drilling length and 2m or less.



Fig. 103.

4. Whole cleaning Engineering.

Mounting the air hose through the adapter to the stiffener (Su~iberu may be used), it is subjected to cleaning in the hole while the upper and lower reinforcement members, so as not to disturb the grouting, remove slime remaining in the hole to.



Fig. 104.

5. Injection Engineering.

Grout material.

Using cement, ordinary Portland cement specified in JIS R 5210 "Portland cement" is the standard, in the case of requiring early strength, uses the early-strength Portland cement.

Admixture as well as improves the properties of the grout, used to adjust the speed of condensation and initial curing of the grout.



Fig. 105.

6. Confirmation test engineering.

The purpose and the number of test.

Confirmation Test Engineering intended to be performed in order to verify whether a reinforcing material has been constructed satisfies the predetermined design tensile force, 3% of the total number or, is carried out for a large number of least three.

It should be noted that, if the predetermined value not obtained in this study, I would discuss the supervisors and their countermeasures.



Fig. 106.

7. Bearing plate installation Engineering.

Bearing plate installation.

Bearing plate was placed in a reinforcement head, fixed a cap washer and nut.

In addition, Bearing plate bottom surface to be in close contact with the ground, is not the land of the Bearing plate installation range to fill the shaping or dry mortar, etc. in advance.

Bearing plate installation procedure is as follows (fig. 107).

8. Head coupling member attached Engineering.

Head connecting member-connecting situation (fig. 108).



Fig. 107.

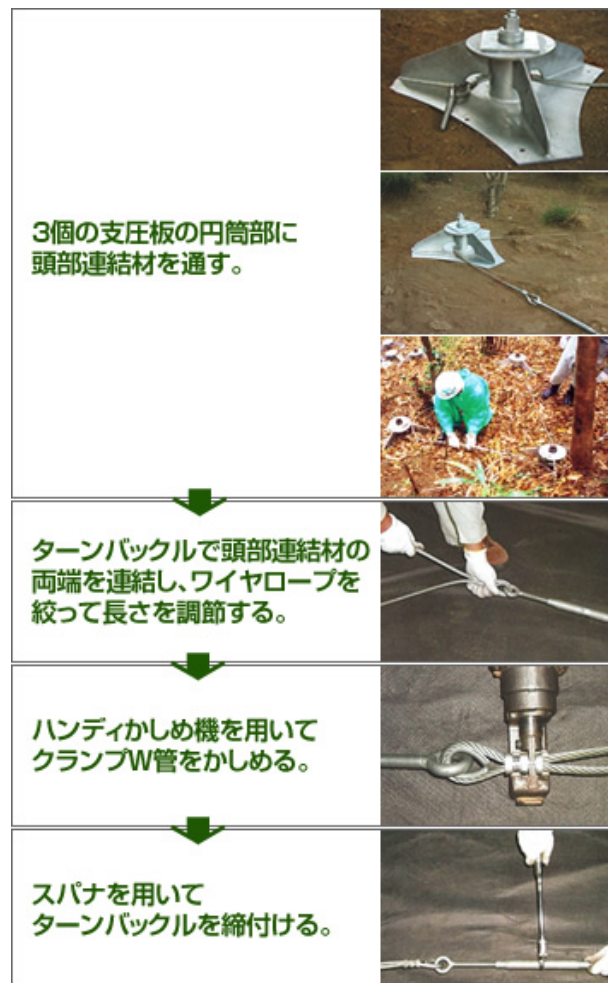

Fig. 108.

Construction control.

Construction management intended to be carried out in order to terminate the construction of a given quality in safety and in the construction period, taking into account the construction conditions and construction scale, in consultation with the order's specifications and supervisors, management items and frequency, etc.

Safety measure.

When working performed to fall prevention treatment, if necessary.

If there is a lifting stones targeting the slopes, in consultation with the supervisor for the sake of safety of the work and take action as described below.

- (1) It will be removed from the slope.
- (2) It is fixed to the base in fixed or roots solid Engineering.
- (3) It is providing a safety fences.

【安全防護柵設置例】



Fig. 109.

When planning of non-frame construction method, in advance to investigate consider the following matters, it is safe, it must be planned with consideration to the rational and the surrounding environment. It should be noted that the purpose of the construction work, you need to add the survey item by construction place and working conditions.

1. Design documents, construction cases of the district.
2. Ground conditions, the ground surface situation.
3. Adjacent structure, the status of the buried structures.
4. Work restrictions, environmental protection regulations, construction related laws and regulations.
5. Power, water, waste disposal.

Note that the content described in the construction plan are as follows.

1. Construction purpose.
2. Construction overview (name, location, construction period, ordering party, contractor, quantity, etc.).
3. Planning, design conditions.
4. Construction planning (process, organization, use machinery, materials used, temporary equipment, work procedures).
5. Construction management plan.
6. Quality management plan.
7. Safety Management Plan.
8. Technical documentation catalogues.

Maintenance, the facility administrator done depending on the management guidelines that defined for slope disaster prevention. It should be noted that, after the heavy rains and earthquakes (guideline seismic intensity 5 or more), perform the inspection on the status of the slope change like presence and superstructure as possible. And to clarify the cause if Hen-jo is seen in the slope, there is a need to consider the precise measures.

5. MUDFLOWS AND INFORMATION.

5.1. Mudflows in Uzbekistan.

A mudflow or mud flow is a form of mass wasting involving "very rapid to extremely rapid surging flow" of debris that has become partially or fully liquefied by the addition of significant amounts of water to the source material.

Mudflows contain a significant proportion of clay, which makes them more fluid than debris flows; thus, they are able to travel farther and across lower slope angles. Both types are generally mixtures of various kinds of materials of different sizes.



Fig. 110.



Fig. 111.

In Uzbekistan, the monitoring carried out in accordance with the decree of the President of the Republic of Uzbekistan - "On Measures to prevent emergencies. Related to the flood, mudflow, avalanche and landslides, and mitigation" 585 from February 19, 2007, which defines the tasks involved, ministries and agencies for organizing the monitoring of hazardous natural and anthropogenic phenomena and mitigation.

The tasks of monitoring include:

- Determination of a representative spatial and temporal spread of dangerous meteorological phenomena based on statistical analysis of historical and newly received data;
- Assessment of current and future state of objects representing a potential threat of severe weather events;
- Preparation of background and specific warnings about the occurrence of severe weather events in the short-term (up to 5 days) and long-term (6 months) outlook;
- Inventory of hazardous weather phenomena.

Tools for monitoring:

- Network hydrometeorological stations and posts (145 gauging stations and 78 meteorological stations, 30 agrometeorological posts) including 18 meteorological stations of international exchange, 9 stations hydrometeorological information exchange with the CIS countries, 10 gauging cross-border monitoring;
- Aerovisual survey (95 observation points);
- Specialized forwarding the survey;
- Remote sensing (satellite imagery NOAA 17, 18).

In Republic of Uzbekistan monitoring of mudflows are Centre of Hydrometeorological Service at Cabinet of Ministers of the Republic of Uzbekistan (Uzhydromet).

Centre of Hydrometeorological Service (Uzhydromet).

Centre of Hydrometeorological Service at Cabinet of Ministers of the Republic of Uzbekistan (Uzhydromet) is the state governing body specially authorized for the solution of tasks in the field of hydrometeorology in the Republic of Uzbekistan.

The objectives of Uzhydromet are the development and improvement of the state system of hydrometeorological observations, hydrometeorological provision of the sectors of economy, scientific research activities, improvement of short-term and long-term weather forecasts, water availability of rivers, climate

change.

Observations of water regime of hydrological objects in the basins of Amudarya and Syrdarya rivers and their components. Uzhydromet conducts hydrometeorological and agrometeorological observations on the whole territory of the Republic of Uzbekistan. In the zone of responsibility of Uzhydromet, the stations that have long terms of observation are located.

Main objectives and tasks of hydrometeorological monitoring are provision of users with hydrometeorological data and prognostic and analytical information prepared on its base.

Uzhydromet is the component of one of UN links – World Meteorological Organization (WMO), the main aim of which is weather and climate observation, cooperation for collection and exchange of data of meteorological, hydrological and other observations of environment conditions.

Since 1967, Tashkent is one of 29 Regional Meteorological Centers, which fulfills collection of meteorological information, preparation and dissemination of weather and forecasting charts in Central Asian and Middle Eastern states and Asian part of Russia. It is the zone of responsibility of Uzhydromet in the system of World Weather Watch (WWW).

The network united under Uzhydromet includes more than 400 stations of environment observation. Meteorological, hydrological and agrometeorological observations carried out on the territory of republic since 1921. The ecological observations of the conditions of water bodies, air and soil carried out since 1972.

Monitoring Mudflows.

The main sources of surface runoff in the Central Asian region are Transboundary Rivers Amudarya and Syrdarya, the average annual flow of which is - 78.5 and 37.1 cubic km / year respectively, and to the basins of the rivers, most of which belong to the region. The main flow of the river Amu Darya - 83% formed on the territory of Tajikistan, the Syrdarya river flow by 80% formed on the territory of Kyrgyzstan. Much of the territory occupied by mountains of the Central Asian Republics and this determines the specific form of floods. In Kyrgyzstan Mountains, cover 95% of the total, 93% in Tajikistan, Uzbekistan about 30%, Turkmenistan - 28%.

Spring and summer - the main phase in the hydrological regime of the rivers of Central Asia, during which takes place from 70 to 80% of annual runoff. On most rivers at this time of the year, there is the greatest water flow. The nature of the formation of flood and flood depends on a variety of meteorological factors and the physical and geographical features of the river basins that are in a relationship create different conditions for their formation in any given year. When a certain combination of these factors generated outstanding floods and floods.

Often such anomalies water availability acquire the character of natural disasters, which caused considerable human and material losses.

It should be noted that in terms of the damage, the most attention in the Central Asian region deserve mudflows and floods, formed as a result of high altitude lake.

Mudflows are widespread throughout the mountain and foothill part of Uzbekistan (fig. 110), and are often cross-border nature, since the majority of mudflows formed on the territory of neighbouring states – Kyrgyzstan and Tajikistan.

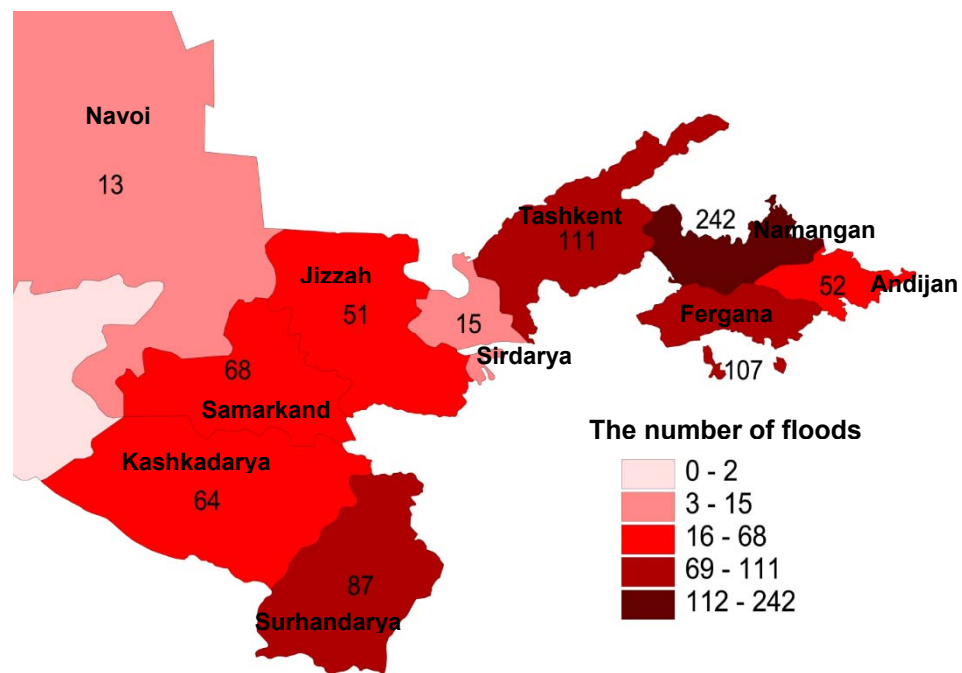

Fig.112. Areas affected by the danger of mudflows.

These long-term observations of the manifestations of debris flow activity and its spatial and temporal variability of the territory of Uzbekistan the following conclusions:

✓ As a whole, in the republic, the area of the mudflows active streams is 53770 km² (12% of the total territory of the Republic of Uzbekistan), the number of streams mudflows active – 709, the number of national economic and others. Objects in the mudflow zone – 858;

✓ Mudflows most exposed to danger: Namangan (19%), Fergana (14%), Surhandarya (13%), Tashkent (12%), Samarkand (12%) and Kashkadarya region (12%);

✓ The highest number of landslides were registered on the territory of the districts located in the Fergana Valley (40%), characterized by the highest density of population;

- ✓ Peak of debris flow activity to the territory of Uzbekistan is in April (30%) and the month of May (36%);
- ✓ Mainly mudflow activity (85%) on the territory of Uzbekistan due to heavy rains and rains of high intensity.

One of the powerful village-forming factors are of high altitude lake. Lakes Breakthroughs do not happen often, but are extremely destructive. Employees Uzhydromet together with representatives of the Ministry of Emergency Situations conducted special observations of the state of some of the glacial lakes.

Total number of glacial lakes that threaten the territory of Uzbekistan located on the territory of Uzbekistan and neighbouring territories is – 315, glacial lakes spread diagram is shown in Figure 111.



Fig. 113. The scheme of distribution of glacial lakes.

The most dangerous and less predictable breakthroughs of moraine lakes. Most moraine lakes formed in recent decades due to the rapid retreat of glaciers.

The mechanism of self-destruction was observed at the dam lake outburst that led to the formation of the catastrophic mudflows, past the river Shahimardan in July 1998.

Flood of 1998 on the river Shahimardan formed as a result of the breakthrough three moraine lakes formed on the end moraines and "dead" ice below the glacier Archabashi on the territory of Kyrgyzstan, in the upper reaches of the same river – one of the components of the river Shahimardan flowing in the Fergana Valley, located on the territory of Uzbekistan. As a result, spreading

floodwater flow in the region of Shahimardan was equal to 150-200 m³ / s. This led to the deaths of more than a hundred people and caused enormous damage to the facilities.

In the case of glacial moraine lakes and virtually impossible to predict the beginning of the flood. But it is possible to identify areas where floods are possible, and to determine the periods when they are most likely occurrence. Typically, this is the hottest time of the summer, when the moraine and glacial lake overflow water.

Preventing floods flood risk.

✓ Much attention paid in Uzbekistan to the development and improvement of methods of prevention mudflows danger. Warning threat of flood, various origins include:

✓ Compiling short-term background of warnings about the possibility of the mudflows and floods on the basis of an assessment form factors (rainfall, their intensity, the state of the snow cover, air temperature);

✓ Alert stakeholders about the passing of the risk of floods and mudslides on the approved scheme warning;

✓ alert the public about the passing of the risk of mudslides and floods;

✓ Risk Assessment threat mudflows and floods on specific objects based on specialized research. Design and construction of protective structures.

✓ Issuing regulations on carrying out the necessary steps to protect the public, staff and facilities from mudflows threats and monitoring their implementation.

5.2. Mudflows in Japan.

The phenomenon of debris flow has been recognized since ancient times in Japan, where debris flow disasters have caused damage and suffering. In steep mountainous areas of Japan, residents have given evocative names to debris flows to warn future generations of their danger. Such names include “Ja-nuke” (the runoff of the king snake), “yama-tsunami” (mountain tsunami), and “yama-shio” (mountain tide). However, because debris flows usually originate on remote high mountain slopes or steep ephemeral gullies and arise during adverse weather conditions, the characteristics and mechanisms of debris flows had long remained poorly understood and the phenomenon was even considered a “phantasmal disaster.”

Scientific investigations of debris flow began in the 1950s and included qualitative discussions of the definition of debris flow. Nomitsu and Seno [1959],

Tani [1968], and Murano [1968] defined debris flow as the gravitational motion of a porridge-like mixture of sediment and water, in which the volume of sediment is much larger than the volume of water. Koide [1955] classified debris flow into “yama-tsunami” and “doseki-ryu” types. He defined a yama-tsunami as the pushing ahead of a cohesive earth mass produced by a landslide along a valley and a doseki-ryu as the pushing ahead of sediment accumulated on a gully bed. Thus, a doseki-ryu had no direct relationship to a landslide. Kaki [1954] defined a yama-tsunami as a forward-moving mixture composed of 70% soil and 30% water and a doseki-ryu as a flow composed of 30% soil and 70% water with relatively thin depth. The term doseki-ryu is now widely used in Japanese to refer to debris flow; “doseki” means a mixture of soil and stone, and “ryu” means flow.

Tani [1968] classified three types of debris flow initiation: 1) transformation of a landslide block into debris flow, 2) collapse of a landslide dam, and 3) sediment entrainment into the surface water flow on a gully bed. He also compiled several observed characteristics of debris flow: 1) the lateral surface profile of flow is upward convex, with the front part swelling longitudinally. 2) The flow is dominated by soil and stone rather than water and resembles a moving hill composed of stone, sand, mud, and wood that produces a smoke-like cloud of debris and a bad smell. 3) The sound is like that of thunder or a formation of airplanes.

Yano and Daido [1965] referred to debris flow as “mud flow.” They defined it as a flow of muddy clay and modeled its motion by applying concepts of pseudoplastic fluid and Bingham fluid. Full investigations were not undertaken until the 1970s. By that time, improvements of major rivers had lessened the risk of large-scale flooding disasters. However, management of minor rivers lagged behind that of major rivers, and the use of slope lands for human activities increased vulnerability to sediment hazards. Before 1964, among human victims of total water-related hazards, 32% were affected by sediment events. Since 1965, this percentage has increased to approximately 50% [Takahashi, 2009]. This situation provides strong motivation for research on debris flow and other sediment hazards.

Natural conditions of Japan.

Seventy per cent of the Japanese archipelago is mountainous. About 120 million people live on densely populated plains, alluvial fans, slope foothills, and slopes. The mountains are high and the rivers draining these are short with steep gradients. Flood waters are therefore fast moving. Japan has a summer rainy season in June and July called the Baiu season, and an autumn rainy period in September and early October characterized by tropical low-pressure systems (typhoons). These rains supply the water needed for growing rice and other crops, but sometimes their intensity causes damaging debris flows and landslides.

SABO is a Japanese term that means erosion and sediment control works. The Japanese style of SABO erosion control works is more intensive than Western erosion control works. The term SABO is known internationally, and is used both in and outside Japan.

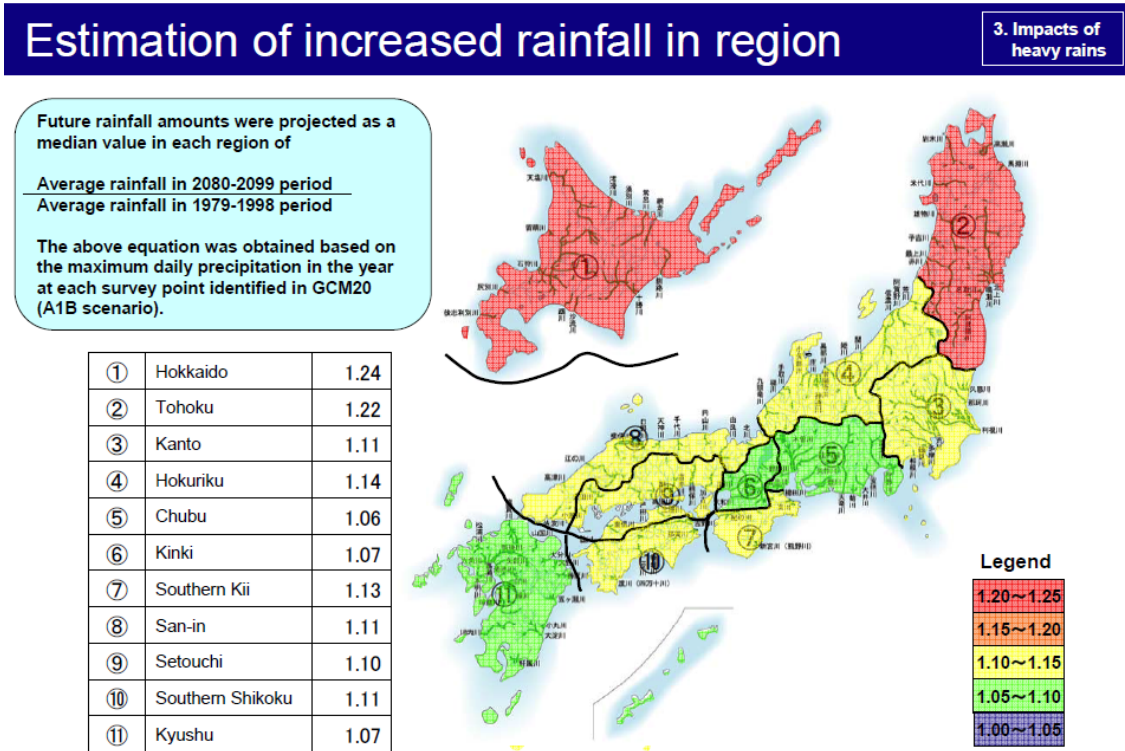

Fig. 114.

Sediment-related disasters in Japan.

A total of 12.1 million people are threatened with sediment-related disasters in Japan.

Table 7.

Prefecture	Number of mountain streams at risk of debris flow	Places at risk of landslide	Places at risk of steep slope failure	Places at risk of avalanche
Hokkaido	1,607	437	3,158	1,151
Aomori	645	63	1,318	892
Iwate	2,204	191	1,792	333
Miyagi	1,359	105	1,841	110
Akita	1,692	262	1,318	1,052
Yamagata	1,268	230	585	839
Fukushima	1,678	143	1,435	200
Ibaraki	537	105	1,105	-

Tochigi	1,043	96	887	142
Gunma	1,863	213	1,667	464
Saitama	585	110	825	-
Chiba	212	52	1,613	-
Tokyo	391	26	2,046	-
Kanagawa	705	37	2,511	-
Niigata	2,544	860	1,975	1,421
Yamanashi	1,653	104	1,412	56
Nagano	4,043	1,241	3,205	910
Toyama	556	194	1,004	712
Ishikawa	1,030	420	1,177	1,285
Gifu	2,934	88	2,957	847
Shizuoka	2,311	183	3,749	40
Aichi	1,555	75	2,910	-
Mie	2,693	85	4,090	-
Fukui	2,080	146	1,588	849
Shiga	1,421	62	1,317	299

Table 8.

Prefecture	Number of mountain streams at risk of debris flow	Places at risk of landslide	Places at risk of steep slope failure	Places at risk of avalanche
Kyoto	2,328	58	1,637	687
Osaka	1,009	145	896	-
Hyogo	4,310	286	5,557	826
Nara	1,136	106	1,289	-
Wakayama	2,526	495	3,144	-
Tottori	1,626	94	1,530	1,121
Shimane	3,041	264	2,874	516
Okayama	3,019	198	2,475	256
Hiroshima	5,607	80	6,410	234
Yamaguchi	2,655	285	3,865	-
Tokushima	1,129	591	2,097	-

Kagawa	1,592	117	929	-
Ehime	3,540	506	2,750	-
Kochi	1,939	176	4,175	-
Fukuoka	2,508	215	3,566	-
Saga	1,760	200	1,759	-
Nagasaki	2,785	1,169	5,121	-
Kumamoto	2,120	107	3,552	-
Oita	2,543	222	4,927	-
Miyazaki	1,413	273	2,823	-
Kagoshima	2,160	85	4,231	-
Okinawa	163	88	465	-
Total	89,518	11,288	113,557	15,242

The above figures for debris flow and slope failures, avalanche, and landslide are published in fiscal 2003, 1997, and 1998 respectively.

Table 9.

Total population in the threatened area preserved	Population in the mountain streams at risk of debris flow	Population in the places at risk of landslide	Population in the places at risk of steep slope failure	Population in the places at risk of avalanche
About 12.1 million people	About 4.3 million people	About 1.6 million people	About 6.2 million people	Population in the places at risk of avalanche

Administrative organizations engaged in erosion and sediment control.

Erosion and sediment control works are administered and conducted under the authority of two governmental organizations: (1) the erosion department of the Ministry of Land, Infrastructure and Transport, formerly the Ministry of Construction; and (2) the Forestry Agency of The Ministry of Agriculture, Forestry and Fisheries. The former is responsible for erosion and sediment control mainly related to rivers, while the latter agency focuses on erosion control to conserve forest lands. There are 47 prefectures in Japan; in each prefecture, the Agriculture and Forest Department and the Sabo Section of the Public Works Department are responsible for erosion control works.

Countermeasures adopted in the Sabo works.

Structural measures and nonstructural measures are applied to mitigate sediment hazards, termed 'hard' and 'soft' measures, respectively, in Japan. Hard countermeasures include construction of SABO dams, channels and hillside works, and restoration of vegetation. Soft countermeasures include conservation land-use practices, warning systems, and preparedness, such as emergency planning and evacuation measures.

Current research and development of SABO works in Japan includes:

- 1) Mechanisms of rainfall runoff, debris flows, landslides, sediment transport, lava flows, and snow avalanches.
- 2) Sediment control planning at the river basin scale.
- 3) Sediment management from mountains to coastal zones.
- 4) Debris flow control structures; open-type SABO dams.
- 5) Prediction of debris flow occurrence, including the location, time, and magnitude of the event, as well as effects on the impacted area.
- 6) Prediction of landslides, including the location, time, and magnitude of the event, as well as effects on the impacted area.
- 7) Analysis of critical rainfall characteristics that trigger debris flows and landslides.
- 8) Landslides triggered by earthquakes.
- 9) Natural landslide dams and their outburst.
- 10) Development of SABO structures and works, taking into consideration natural environment preservation in mountains and mountain torrents; for example preserving fish, animal, and insect populations along rivers prone to torrents.
- 11) Countermeasures against shallow and deep-seated landslides.

Debris Flow Measures.

Building Sabo dams upstream traps the sediment there and prevents it from eroding and flowing downstream. Sabo dams also serve to stop debris flow.

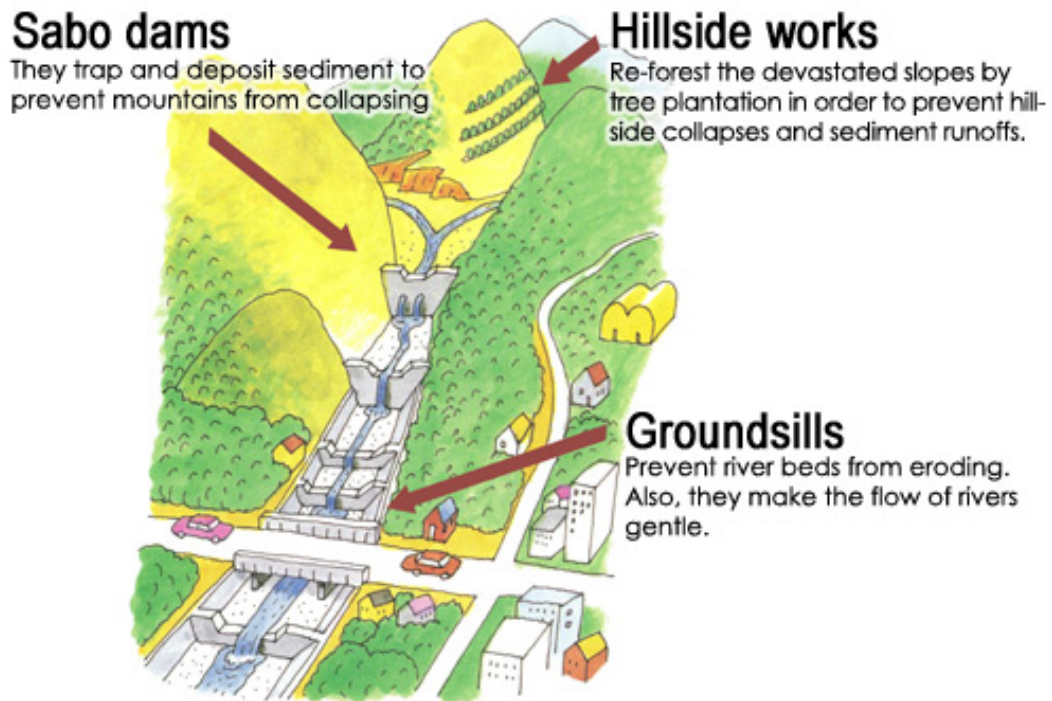

Fig. 115.

A debris flow is generated by severe erosion of the torrent bed in source areas, as small temporary natural landslide dams burst and contribute to a debris flow of the landslide mass, including a large volume of water. It is not known what triggers the debris flow in a specific torrent. Several surges are often observed during one debris flow event, as shown in Figure 115. The frequency of debris flow is low, occurring once approximately every 100 years or more. Sabo dams intended to control debris flows may fill with sediment and trash, mainly woody debris, before a debris flow occurs. Maintaining the debris flow trap at its design capacity requires excavating this accumulation.

Open-type Sabo dams incorporating steel pipes or iron bars have been used as debris flow control structures for more than 30 years; the opening is designed to trap large boulders from the debris flow front. Flume experiments have revealed that the most effective opening size for trapping debris flow is 1.5 times, or less, the maximum grain size that is likely to be concentrated at the front part of a debris flow. When they were first developed, these dams were designed to be self-cleaning. Researchers assumed that after the structure trapped a debris flow, subsequent ordinary flow would gradually erode the trapped fine sand and gravel, and debris flow trap capacity would be restored automatically. This rarely ever

happens in actuality because ordinary flow discharge is generally not sufficient to erode trapped sediment. After large boulders and woody debris are trapped by the open dams, almost all sediment except the washload is deposited upstream of the Sabo dam (figure 116) where it must be excavated by heavy machinery. Before such excavation equipment was available, a new Sabo dam was constructed after the original dam was filled with sediment.



Fig. 116. Open steel pipe in a Sabo dam.



Fig. 117. Grid Sabo dam with trapped debris flow.

Note that fine sand is trapped as well as large boulders and woody debris

In the early 2000s, concrete-slit Sabo dams were constructed as debris flow control structures. These are now considered unsafe because the narrow slits may cause water to back up. The debris flow is not stopped by the slit but instead stops in the low-flow velocity zone of the Sabo dam, so that deposited sediment may be eroded and flow through the slit (see photos 117 and 118). These concrete-slit dams are no longer constructed, and lateral steel bars are generally installed in the slits of existing concrete-slit Sabo dams.



Fig. 118. Concrete-slit Sabo dam before sediment discharge.



Fig. 119. Sediment originally trapped upstream of the slit dam, released during the recession period, and deposited again downstream of the sabo dam.

Debris flow barrier or wire net.

A wire net can be used to trap a debris flow. The advantage of this structure is that it does not require people to work inside a torrent bed. After a debris flow, the debris is removed and the wire net is replaced if it has been damaged. Although some doubts have been raised about their durability, nets have been used successfully in Switzerland and Japan (figure 119).



Fig. 120. Debris flow barrier successfully catching the debris flow snout at Mount Tateyama, Japan. Part of the wire (left) was cut by boulders.

Debris Flow Sensors.

1) Wire sensors.

Wire sensors detect a debris flow when the wires laid out inside of river channels get cut by a debris flow. Consequently, every time a wire gets cut by a debris flow, it requires repair work. Prior to installing a wire sensor, it is extremely important to determine the appropriate height at which to install the wire sensor according to the scale of debris flow potentially anticipated in the area. It is also crucial to carefully determine the appropriate positioning of the wires in order to prevent accidental or unintentional activation of the sensor by animals, driftwood, and/or fallen trees.

2) Vibration sensors.

Vibration sensors detect the vibration of the ground soil in case of a debris flow. Prior to installing a vibration sensor, it is extremely important to determine what level of vibration is appropriate to activate the sensor in case of a debris flow.

It is also important to keep in mind the risk of unintentional activation caused by earthquakes, as well as areas in which there is construction traffic and other vibration causes that may activate the sensor.

3) Light sensors.

Light sensors detect a debris flow when they intercept the light axis installed through a river channel. Prior to installing a light sensor, it is important to determine the appropriate positioning. The risk of unintentional activation caused by animals, driftwood, snow, fog, and other conditions, also needs to be taken into consideration.

4) Acoustic sensors.

Acoustic sensors detect the sound propagating underground in case of a debris flow. Prior to installing an acoustic sensor, it is important to determine the appropriate acoustic level at which the sensor is activated. It is necessary to take into consideration the risk of unintentional activation caused by traffic in the area, including construction as well as ordinary traffic.

Needless to say, it is crucial to make sure that all of the workers will have enough time to evacuate far enough from the site once any one of the sensors above is activated and before the debris flow reaches the construction site.

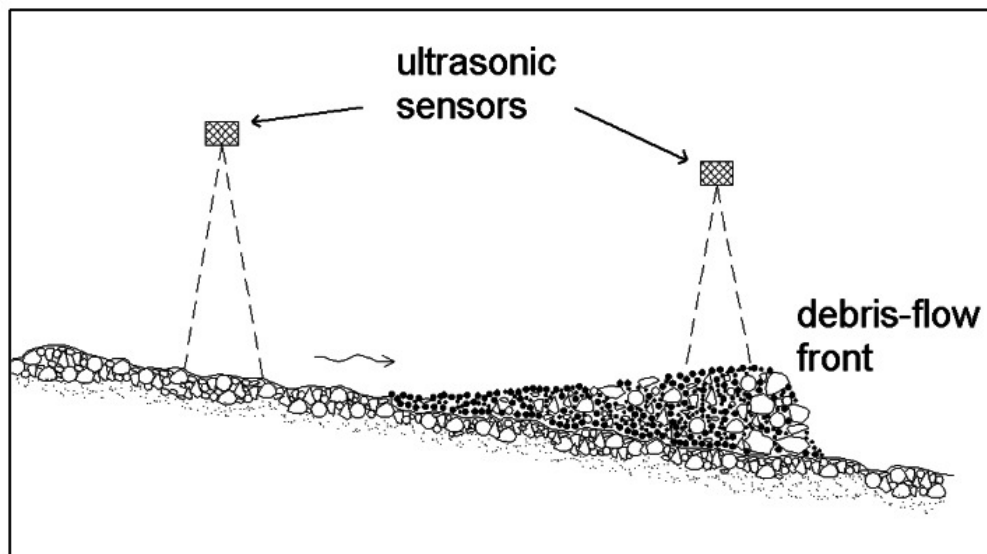

Fig. 121.

Flow depth measurement at two monitoring stations makes it possible to assess mean front velocity (the horizontal scale is shortened with regard to both the distance between the sensors and the debris flow profile).

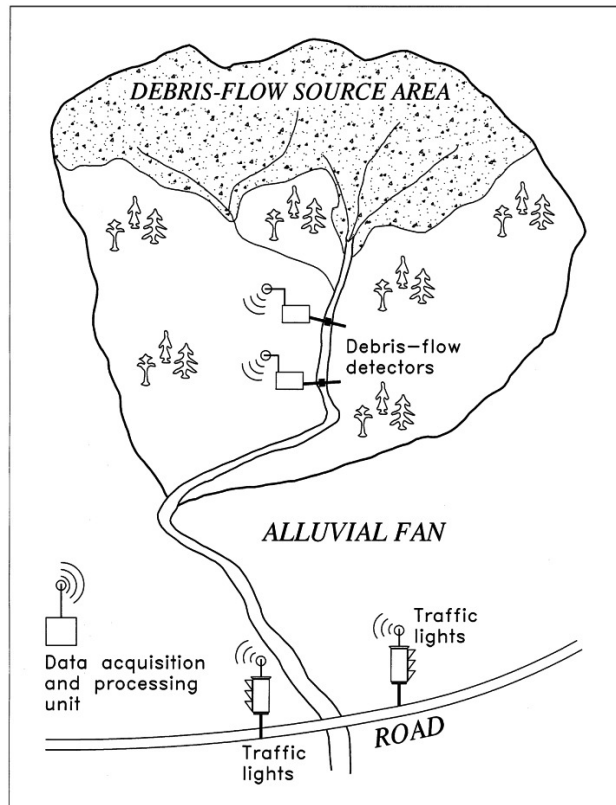

Fig. 122. Sketch of the components of a debris-flow warning system.

Sensors.

The new debris flow monitoring system will be based on the existing infrastructure with several new enhancements. The first is a new type of mobile sensor that will flow with the debris for new types of real-time tracking. The second is to add wireless capability to other types of sensors used in the existing infrastructure. Capsules for the Mass Flow Sensor We envision a mobile sensor, called the Mass Flow Sensor, to be a pyramid-like capsule that normally stands idle along possible debris flow paths and housed in a weather-proof, sturdy enclosure.

Integration with Current Infrastructure The capsule will serve as an initial platform on which different types of sensors can be attached either directly or indirectly.



Fig. 123. Different type of sensors.

6. CONCLUSIONS.

Over the last decade, emergencies caused by natural and man-made disasters have become more frequent and the risk of emergency situations of various origins increased. Because of the different types of natural disasters (earthquakes, tsunamis, hurricanes, tornadoes, floods, mudslides, landslides, avalanches, volcanic eruptions), more than 350 thousand people have died in the twenty-first century. Unfortunately, the number of victims of natural disasters continues to grow every year.

Every disaster brings destruction and loss of life, damages the environment. The surface of the Earth will change continuously under the influence of natural processes. Landslides will take place on unstable hillsides; will continue to alternate between large and small water in the rivers and storm surges would occasionally flood the sea coast, no cost and no fires. Man is powerless to prevent the natural processes themselves, but in its power to avoid casualties and damages.

It should be noted that, along with its unique geographical position in Central Asia region is highly prone to natural disasters (earthquakes, landslides, mudflows, floods, droughts, etc.). Complex environmental situation existing in the region and elsewhere in the world is primarily due to natural and anthropogenic factors. Therefore, it is imperative that new ways of solving problems developed, including effective cooperation with the international community.

Reduction of losses due to natural disasters is one of the most pressing issues that affect different aspects of human rights (economic, social and cultural).

Every year during the past decade has seen an alarming increase in the incidence of natural disasters, as well as the size of their social, economic and environmental impacts.

Seven thousand cases of natural disasters that have occurred over the last 25 years around the world, have claimed the lives of two million, while the number of victims has exceeded five billion people.

Natural and environmental disasters can occur anywhere in the world, but they are often bombarded disasters with devastating consequences in those countries that are prepared for them the least. Uzbekistan ranks high among countries that have suffered significant loss of life and property as a result of earthquakes and other natural disasters.

As one of the most seismically active regions in Central Asia, Uzbekistan is often experienced an earthquake of eight - ten-point power. In addition to the seismic vulnerability, Uzbekistan threatened and hydrometeorological hazards

that could affect the agricultural sector, in the form of seasonal flooding and periodic droughts.

As we know, Japan is a highly developed country in the world. Nevertheless, every year in Japan, facing natural disasters, such as earthquakes, tsunamis, floods and volcanic eruptions, which cause great damage to the economy and loss of life. The use of modern technologies and has extensive experience in disaster prevention and safety of residents said the leader of one of the countries in the world. Especially for monitoring earthquakes, landslides, floods and the construction of protective structures in mountain and foothill areas.

After the Great Hanshin-Awaji earthquake, the Japanese government pays special attention to natural disasters. For 12 years, the Japanese government has created a unique system to monitor earthquakes, landslides, floods, and tsunamis, weather, etc. and early warning of tsunamis, earthquakes, floods. The early warning system was launched in 2007.

Japan has a wealth of experience and knowledge to mitigate and prevent natural disasters, in which the whole world takes the example, including Uzbekistan. For achievement that the people of Japan have experienced a lot, the result has demanded full commitment and full involvement of all relevant subjects, including Governments, regional and international organizations, civil society including volunteers, the private sector and academia.

Currently Goscomgeology collaborates and interested in further cooperation with ADRC mitigation of natural disasters, with the common goal of substantial reduction of the victims, the early warning of the dangers and to reduce the social, economic and environmental assets of communities.

In Japan, I spent a wonderful time. I learned about a new system of disaster management, early warning and disaster prevention.

I would especially like to stay at the developed method to prevent landslides “New nailing network system” which is very effective for the reinforcement of landslides preserving the natural surface structure of the environment.

After returning to the country, I plan to show presentation about Disaster management system and recommend this “New nailing network system” the chairman. I also plan to prepare a lecture for primary school students about natural disasters and the action in the event of disaster, with intended installation examples.

Firstly, I want say thank you Shiomi san for organizing all meetings, lectures, presentations, trips and for wholesome advice. And also thanks all the staff ADRC for hospitality and cooperation.

Thank you very much!